

Shown with optional USB Interface daughterboard

ASSEMBLY MANUAL - RAAS-4a Remote Automatic Antenna Switch Kit

Revision History

| Revision Number | Date | Description | Notes |
|-----------------|-----------|--|--|
| 1.1 | 2/14/2022 | <ul style="list-style-type: none"> Moved small component assembly steps up in the order to allow for easier insertion and soldering. Assorted minor grammar and image editing. | As per suggestion from Mark – K4SO |
| 1.2 | 2/15/2022 | <ul style="list-style-type: none"> Modified step 131 to add “(or, approximately 200kΩ if using the meter’s resistance setting)” Changed the stripe color of the Zener diodes from white to black. | <p>For more accuracy on the antenna selection tests</p> <p>To reflect the new Zener diode version</p> <p>Many Thanks to Mike - K9MWG</p> |
| 1.3 | 2/21/2022 | <ul style="list-style-type: none"> Added soldering tip for installing the 8-pin headers used by the optional USB module. Added a missing step for installing capacitor C5. Changed the jumper and voltage measurement location from R31 to R30 in steps 71 and 72. Also changed the images to reflect this. Steps 131 and 134 - changed the phrase “approximately 200kΩ” to “greater than 150KΩ” to accommodate a slightly different resistance reading when antenna #4 is selected. | <p>Due to feedback from several sources – many thanks to:</p> <p>Frank – W4TG</p> <p>KD – KD9S</p> |
| 1.4 | 3/5/2022 | <ul style="list-style-type: none"> Changed all microcontroller references to a generic PIC model due to varying availabilities of individual models. Changed the version number and photo of the optional USB Interface Module in the Main Board Parts Inventory to reflect the newest version. Changed photos to reflect new power switch cable and CN3 header assembly. Added a check to the optional USB interface final installation step to ensure the switch model jumper is installed correctly. | |
| 1.5 | 5/25/2022 | <ul style="list-style-type: none"> Added type variation text and picture for the .0068 μF capacitors found on the remote relay and bias-T circuit boards. | |
| 1.6 | 3/10/2023 | <ul style="list-style-type: none"> Corrected labeling on the remote antenna switch unit schematic to correctly designate TP2. Changed parts inventory photos to reflect changes to several components related to supply chain issues. | |

| | | | |
|------------|-----------|---|--|
| | | <ul style="list-style-type: none"> Changed parts inventory photo for the trimmer resistor R71 to reflect changes made to make the Icom Band Data adjust less touchy. | |
| 1.7 | 5/25/2023 | <ul style="list-style-type: none"> Changed the sequence for plugging in the front panel ribbon cables so that they are already attached before mounting the front panel circuit board to the enclosure. Added fuse holder and ½ amp fuse to parts list as well as the steps to install same. Updated the main circuit board version number accordingly. | |
| 1.8 | 8/25/2023 | <ul style="list-style-type: none"> Modified parts list entry for the .0068 µf (6.8 nf) ceramic disk capacitors used in the both the Bias-T box as well as the remote relay box to reflect the current supply chain. Updated circuit board version numbers in the parts list. | |

CONTENTS

Getting Started1

 Required Tools and supplies1

 Recommended Tools1

 Parts Inventory1

 Tips for Successful Soldering10

Circuit Board Assembly12

 Controller Main Board12

 Controller Front Panel17

 Remote Antenna Relay Board20

 Bias-T Board21

Final Assembly23

 Controller23

 Front Panel23

 Main Board23

 Power Switch and Ribbon Cables24

 Adjust Icom Band Data Voltage Divider25

 Install the three MOC3063 Opto-Coupler chips26

 Install PIC Microcontroller Chip27

 Remote Antenna Relay Box28

 Mounting the Circuit Board28

 Installing the 100kΩ Resistors30

 Bias-T Box31

 Installing the connectors31

 Mounting the circuit board32

 Building the interface cable36

Testing40

 Manual Mode40

 Auto Mode42

 Remote Relay Box42

Troubleshooting44

Schematic Diagrams50

GETTING STARTED

These instructions are specifically structured to guide you through the steps required to easily complete the assembly of the remote antenna switch. The order of the sections and steps has been chosen to reduce any instances where awkward soldering or physical assembly would be needed. For instance, resistors are installed early in the main board assembly since they sit very close to the circuit board and have less chance of interfering with component placement while installing any later components such as the transistors and voltage regulators.

There are no “hard” soldering tasks on this kit. Anyone with beginner-level or better soldering skills should be able to successfully complete that portion of the assembly.

REQUIRED TOOLS AND SUPPLIES

The following tools and supplies are required to complete the assembly of the remote antenna switch:

- Soldering Iron – At least 60 watts with a thin tip is recommended. A temperature-controlled soldering station would be preferred.
- Rosin core solder – please see the soldering tips section below for a discussion on choosing between leaded or non-leaded solder compositions.
- #1 and #2 phillips-head screw drivers
- Small straight-slot screwdriver – used to adjust a variable resistor, so a blade width of 1/8” to 3/16” is recommended.
- Small needle-nosed pliers
- Small diagonal wire cutters
- Nut drivers (or sockets/wrenches) in the following sizes: 3/16”, 1/4”, 5/16”, 3/8”
- Wire strippers
- Multi-meter w/ test leads (not shown)



Figure 1 - Required Hand Tools

RECOMMENDED TOOLS







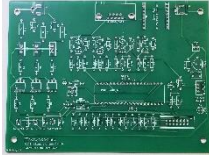

The following tools are recommended to make the assembly process easier and more precise, but are not required:

- “Helping Hands” station equipped with a magnifying glass.



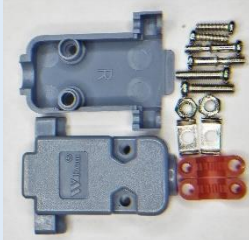



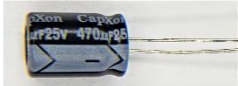



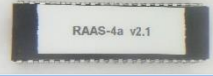

PARTS INVENTORY

After unpacking all kit components and hardware, please refer to the following tables to ensure everything has been included and identified before moving to the actual assembly sections of this manual. If anything is missing, please contact the seller for replacements.

Table 1 – Controller Main Board Parts

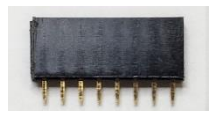
| <input checked="" type="checkbox"/> | Component | Qty | Circuit Designator(s) | Identifying Marks | Image |
|-------------------------------------|---|-----|---|-------------------|---|
| <input type="checkbox"/> | Controller Enclosure | 1 | Only provided with kits where the enclosure was purchased as part of the kit. | N/A |  |
| <input type="checkbox"/> | Circuit Board – Controller Main Board | 1 | N/A | Rev 6.4 |  |
| <input type="checkbox"/> | AC/DC PCB Mounted Power Jack | 2 | J1 and J3 | N/A |  |
| <input type="checkbox"/> | 12V 1A AC Power Supply Wall AC Adapter | 1 | N/A | N/A |  |
| <input type="checkbox"/> | DB-9 Male Right Angle Socket | 1 | J2_BAND_DATA | N/A |  |
| <input type="checkbox"/> | DB-9 Female connector | 1 | N/A | N/A |  |
| <input type="checkbox"/> | DB-9 Connector Backshell Assy | 1 | N/A | N/A |  |
| <input type="checkbox"/> | Fuse Holder (main circuit board version 6.3 or later) | 2 | FH1, FH2 | N/A |  |
| <input type="checkbox"/> | 1/2 Amp fuse 1/4" dia. X 3/4" long (main circuit board version 6.3 or later) | 1 | N/A | 500mA L 250V |  |
| <input type="checkbox"/> | 0.1 µf Ceramic Disk Capacitor | 9 | C1, C2, C6, C7, C8, C9, C10, C11, C12 | 104 |  |
| <input type="checkbox"/> | .33 µf Ceramic Disk Capacitor | 1 | C5 | 334 CSK |  |
| <input type="checkbox"/> | 470 µf 25v Electrolytic Capacitor | 1 | C3 | 470 µf 25v |  |

| <input checked="" type="checkbox"/> | Component | Qty | Circuit Designator(s) | Identifying Marks | Image |
|-------------------------------------|-----------------------------------|-----|---|---|---|
| <input type="checkbox"/> | 100 µf 25v Electrolytic Capacitor | 1 | C4 | 100 µf 25v |  |
| <input type="checkbox"/> | 12Ω ¼ Watt Resistor | 3 | R7, R8, R9 | brown / red / black / gold |  |
| <input type="checkbox"/> | 430Ω ¼ Watt Resistor | 3 | R1, R2, R3 | Yellow / orange / brown / gold |  |
| <input type="checkbox"/> | 330Ω ¼ Watt Resistor | 6 | R14, R47, R48, R51, R52, R53 | orange / orange / brown / gold (Resistor body color may vary) |  |
| <input type="checkbox"/> | 1kΩ ¼ Watt Resistor | 11 | R16, R19, R20, R23, R24, R27, R28, R31, R33, R34, R45 | brown / black / red / gold |  |
| <input type="checkbox"/> | 3.3kΩ ¼ Watt Resistor | 3 | R4, R5, R6 | Orange / orange / red / gold |  |
| <input type="checkbox"/> | 4.7kΩ ¼ Watt Resistor | 7 | R32, R60, R61, R62, R63, R64, R65 | yellow / violet / red / gold |  |
| <input type="checkbox"/> | 10kΩ ¼ Watt Resistor | 10 | R13, R17, R18, R21, R22, R25, R26, R29, R30, R70 | brown / black / orange / gold |  |
| <input type="checkbox"/> | 10Ω 1 Watt Resistor | 1 | R10 | brown / black / black / gold |  |
| <input type="checkbox"/> | 13Ω 1 Watt Resistor | 1 | R12 | brown / orange / black / gold |  |
| <input type="checkbox"/> | 15Ω 1 Watt Resistor | 1 | R11 | brown / green / black / gold |  |
| <input type="checkbox"/> | 20kΩ Trimmer Resistor | 1 | R71 | W203 13H |  |
| <input type="checkbox"/> | 1N4002 Diode | 1 | D5 | GW918 1N4002 |  |
| <input type="checkbox"/> | 1N4005 Diode | 3 | D6, D7, D8 | 1N4005 |  |
| <input type="checkbox"/> | 3V Zener Diode | 4 | D1, D2, D3, D4 | N/A |  |
| <input type="checkbox"/> | 3mm Red Light Emitting Diode | 3 | Ant 2 Sel, Ant 3 Sel, Ant 4 Sel | N/A |  |

| <input checked="" type="checkbox"/> | Component | Qty | Circuit Designator(s) | Identifying Marks | Image |
|-------------------------------------|---|-----|-----------------------|--|---|
| <input type="checkbox"/> | 2N3904 NPN Transistor | 4 | Q4, Q5, Q6, Q7 | 2N3904 B011 |  |
| <input type="checkbox"/> | BT139-600E Triac | 3 | Q1, Q2, Q3 | B139-600E |  |
| <input type="checkbox"/> | MOC3063 Opto-Coupler | 3 | U3, U4, U5 | MOC3063 |  |
| <input type="checkbox"/> | 6 pin IC Socket | 3 | U3, U4, U5 | N/A |  |
| <input type="checkbox"/> | PIC18F47Q83 Micro-controller | 1 | U1 | RAAS-4a v2.1 |  |
| <input type="checkbox"/> | 40 pin IC Socket | 1 | U1 | N/A |  |
| <input type="checkbox"/> | LM7805 5V Linear Voltage Regulator | 1 | U2_5V_REG | 7805 -or- LM240T5 7805 P+ |  |
| <input type="checkbox"/> | 14 pin IDC Header | 1 | CN1 | N/A |  |
| <input type="checkbox"/> | Optional USB Interface Daughterboard | 1 | N/A | USB to Switch Controller Bridge Module v4.1 |  |
| <input type="checkbox"/> | 8 pin female header | 2 | H1, H2 | N/A (Optional – only supplied with USB interface) |  |
| <input type="checkbox"/> | 5001 Test Ring | 1 | TP1 | N/A |  |
| <input type="checkbox"/> | Toggle Switch | 1 | N/A | N/A (Color may vary) |  |
| <input type="checkbox"/> | 6" x 2 conductor twisted pair cable ass'y | 1 | N/A | N/A |  |
| <input type="checkbox"/> | 2 Conductor JST XH PCB Header | 1 | CN3 | N/A |  |

| <input checked="" type="checkbox"/> | Component | Qty | Circuit Designator(s) | Identifying Marks | Image |
|-------------------------------------|---|-----|-----------------------|-------------------|---|
| <input type="checkbox"/> | 19" Alligator clip jumper wire – color may vary | 1 | N/A | Color will vary |  |
| <input type="checkbox"/> | 6-32 x 3/8 hex standoff | 4 | N/A | N/A |  |
| <input type="checkbox"/> | 6-32 x 1/4 pan head machine screw | 4 | N/A | N/A |  |
| <input type="checkbox"/> | 6-32 hex nut | 4 | N/A | N/A |  |

Table 2 - Controller Front Panel Parts

| <input checked="" type="checkbox"/> | Component | Qty | Circuit Designator(s) | Identifying Marks | Image |
|-------------------------------------|---|-----|-----------------------|-------------------|---|
| <input type="checkbox"/> | Circuit Board – Controller Front Panel Board | 1 | N/A | Rev 3.2 |  |
| <input type="checkbox"/> | TS26 Tactile Pushbutton Switch w/LED 15mm x 15mm | 4 | PB1, PB2, PB3, PB4 | Honyone TS26 |  |
| <input type="checkbox"/> | TS5 Tactile Pushbutton Switch 9.2mm x 9.2mm | 1 | PB5 | Honyone |  |
| <input type="checkbox"/> | 5mm Red Light Emitting Diode | 1 | MANUAL | N/A |  |
| <input type="checkbox"/> | 5mm Green Light Emitting Diode | 1 | AUTO | N/A |  |







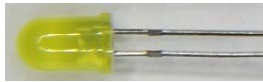

| <input checked="" type="checkbox"/> | Component | Qty | Circuit Designator(s) | Identifying Marks | Image |
|-------------------------------------|--------------------------------------|-----|-----------------------|-------------------|--|
| <input type="checkbox"/> | 5mm Yellow Light Emitting Diode | 1 | XMIT | N/A |  |
| <input type="checkbox"/> | 14 pin IDC Header | 1 | CN2 | N/A |  |
| <input type="checkbox"/> | 3" x 14 conductor ribbon cable ass'y | 1 | N/A | N/A |  |
| <input type="checkbox"/> | 4-40 x 3/8 hex standoff | 2 | N/A | N/A |  |
| <input type="checkbox"/> | 4-40 Hex Nut | 2 | N/A | N/A |  |
| <input type="checkbox"/> | 4-40 x 1/4 pan head machine screw | 2 | N/A | N/A |  |

Table 3 – Antenna Relay Box Parts

| <input checked="" type="checkbox"/> | Component | Qty | Circuit Designator(s) | Identifying Marks | Image |
|-------------------------------------|-----------------------------------|-----|---|--|---|
| <input type="checkbox"/> | Relay Box Enclosure | 1 | Only provided with kits where the enclosure was purchased as part of the kit. | Hammond 1550WC |  |
| <input type="checkbox"/> | Circuit Board - Antenna Relay Box | 1 | N/A | Rev 3.1 |  |
| <input type="checkbox"/> | SO-239 UHF Coax Connector | 5 | N/A | N/A |  |
| <input type="checkbox"/> | DPDT 12V Power Relay | 3 | K1, K2, K3 | Various models may be used. All models will have |  |

| <input checked="" type="checkbox"/> | Component | Qty | Circuit Designator(s) | Identifying Marks | Image |
|-------------------------------------|---|-----|-----------------------|--|--|
| | | | | a minimum current rating of 8A per contact. | Image is typical, color may vary |
| <input type="checkbox"/> | 40 μ H RF Choke | 1 | L1 | N/A |  |
| <input type="checkbox"/> | 18 μ H RF Choke | 1 | L2 | brown / grey / black / silver |  |
| <input type="checkbox"/> | 1N4005 Diode | 2 | D1, D2 | 1N4005 |  |
| <input type="checkbox"/> | 100k Ω 2-Watt Metal Oxide Resistor | 4 | R1, R2, R3, R4 | brown / black / yellow / gold (Resistor body color may vary) |  |
| <input type="checkbox"/> | .01 μ f Ceramic Disk Capacitor | 2 | C1, C2 | F103M 1KV |  |
| <input type="checkbox"/> | .0068 μ f (6.8 nf) Ceramic Disk Capacitor | 2 | C3, C4 | 682 500V (This one is brown) -or- STE 682 2KV (This one is blue) |   |
| <input type="checkbox"/> | 470 μ f 25v Electrolytic Capacitor | 2 | C5, C6 | 470 μ f 25v |  |
| <input type="checkbox"/> | 5001 Test Ring | 1 | TP2 | N/A |  |
| <input type="checkbox"/> | M5 x .80 x 10+7mm hex standoff | 1 | N/A | N/A |  |
| <input type="checkbox"/> | M5 x .80 Hex Nut | 1 | N/A | N/A |  |

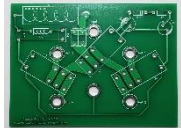







| <input checked="" type="checkbox"/> | Component | Qty | Circuit Designator(s) | Identifying Marks | Image |
|-------------------------------------|---------------------------------------|-----|-----------------------|-------------------|---|
| <input type="checkbox"/> | M5 x .80 x 8mm pan head machine screw | 1 | N/A | N/A |  |
| <input type="checkbox"/> | 14/16-gauge #10 ring terminal | 1 | N/A | N/A |  |

Table 4 - Bias-T Box Parts

| <input checked="" type="checkbox"/> | Component | Qty | Circuit Designator(s) | Identifying Marks | Image |
|-------------------------------------|---------------------------------|------|---|-------------------|---|
| <input type="checkbox"/> | Bias-T Box Enclosure | 1 | Only provided with kits where the enclosure was purchased as part of the kit. | Hammond 1411DU |  |
| <input type="checkbox"/> | Circuit Board – Bias-T Board | 1 | N/A | Rev 3.1 |  |
| <input type="checkbox"/> | SO-239 UHF Coax Connector | 2 | N/A | N/A |  |
| <input type="checkbox"/> | AC/DC Panel Mounted Power Jack | 1 | J1 | N/A |  |
| <input type="checkbox"/> | Controller Interface Connectors | 2 | N/A | N/A |  |
| <input type="checkbox"/> | Controller Interface Cable | 4 ft | N/A | N/A |  |
| <input type="checkbox"/> | #24 Red hookup wire | 3 in | N/A | N/A |  |

| <input checked="" type="checkbox"/> | Component | Qty | Circuit Designator(s) | Identifying Marks | Image |
|-------------------------------------|---|------|-----------------------|--|---|
| <input type="checkbox"/> | #24 Brown hookup wire | 3 in | N/A | N/A |  |
| <input type="checkbox"/> | 40 μ H RF Choke | 1 | L1 | N/A |  |
| <input type="checkbox"/> | 18 μ H RF Choke | 1 | L2 | brown / grey / black / silver |  |
| <input type="checkbox"/> | .01 μ f Ceramic Disk Capacitor | 2 | C1, C2 | F103M 1KV |  |
| <input type="checkbox"/> | .0068 μ f (6.8 nf) Ceramic Disk Capacitor | 2 | C3, C4 | 682 500V (This one is brown) -or- STE 682 2KV (This one is blue) |  |
| <input type="checkbox"/> | 4-40 x 1/2 hex standoff | 2 | N/A | N/A |  |
| <input type="checkbox"/> | 4-40 Hex Nut | 2 | N/A | N/A |  |
| <input type="checkbox"/> | 4-40 x 1/4 pan head machine screw | 2 | N/A | N/A |  |

TIPS FOR SUCCESSFUL SOLDERING

This kit has been designed to ensure relatively easy soldering. Also, the components have been placed on the circuit boards with plenty of spacing. Finally, we have chosen to use all through hole rather than surface mount components to accommodate beginning kit builders.

If this is your first attempt at building an electronics kit, or it has been a while since you've wielded a soldering iron, please refer to the following soldering tips:

1. Wear safety glasses! Consider using a small fan to blow the soldering fumes away from your nose.
2. Use a good soldering iron, or a temperature-controlled soldering station. A soldering station is preferred since it would likely come with a tip cleaning station. See *Figure 2 - Soldering Station Example* for a common example of an inexpensive soldering station. Decent soldering stations will cost about \$20 to \$30.
3. Consider using a "helping hands" station. Some versions of these also include a magnifying glass which will come in handy with some of the smaller components. Refer to *Figure 3 - "Helping Hands" Example* for an example.
4. Use the thinnest solder appropriate for the project – a diameter of around .032 works well for the type of circuit board soldering encountered on this kit.
5. 60/40 (Tin/Lead) solder is recommended for beginners since the lead content lowers the melting point of the solder which allows for much easier soldering. However, lead can be harmful to humans, so there are non-lead solders available. These non-lead types of solder have their drawbacks – the most prevalent being the high melting temperature. In the end, it is up to the individual to decide which type of solder to use.
6. Allow the soldering iron to reach its working temperature before trying to solder any components. A good working temperature for the types of components used in this kit is between 325° F and 375° F. This will also depend on the type of solder being used – please refer to the solder manufacturer's recommendations for the optimum temperature.
7. Tin the soldering iron by applying a small amount of solder directly on the iron's tip prior to touching the iron to the circuit board and component being soldered. The reason for this is that a tinned tip will transfer heat much faster, thus reducing the amount of time needed to get the solder to flow around the component lead and circuit board pad.
8. Try to structure your soldering activities by placing several components on the circuit board before picking up the soldering iron. This allows for more efficient soldering since the iron will remain tinned throughout this soldering cycle.



Figure 2 - Soldering Station Example



Figure 3 - "Helping Hands" Example

9. Apply the tip of the soldering iron evenly to both the circuit board pad and the component lead first. Then touch the solder to the lead and allow it to spread, or “flow” as it’s known in the trade. When you see the solder flow, you will know that you have a strong, well soldered joint.
10. Don't use too much solder– “the bigger the blob, the better the job” is not true here. Some have described the perfect solder joint as looking like a small Hershey’s Kiss (or a small volcano if you don’t like chocolate).
11. Clean the tip often using brass wool, or a damp sponge. Brass wool has become the preferred material since it will not lower the temperature of the soldering tip. The constant cooling and reheating of the tip can shorten its life due to contraction and expansion. However, a damp sponge will clean the tip as well.
12. Don't move the joint while it is cooling, and don't blow on it to cool it off. This can cause a “cold” solder joint which can result in a high electrical resistance between the component and the circuit board.

CIRCUIT BOARD ASSEMBLY

Since most of this kit's assembly is performed on the four circuit boards, it's best to start there. The order of assembling the boards doesn't matter, but the order at which components are placed on each individual board does have a bearing on how easy it is to complete the board. The steps listed within each board's section have been arranged to make it as easy as possible to place and solder the component leads.

CONTROLLER MAIN BOARD

Note: all soldering will be done on the underside of this circuit board.

- 1 Place the socket for the PIC microcontroller on the circuit board.

Important! - Ensure that the small notch on the socket is aligned with the outline printed on the circuit board.

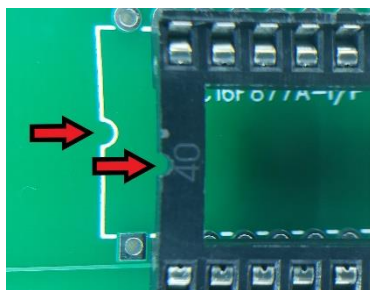

Turn the circuit board over while holding the socket in place, and carefully lay the board down on the work surface. Ensure that all 40 pins are still protruding through the circuit board. Solder one of the pins while ensuring that the socket remains flush with the circuit board. Then solder the remaining 39 pins before moving to the next step.

- 2 Place one of the 6-pin IC sockets at location marked: **U3**.

Important! - Ensure that the small notch on the socket is aligned with the outline printed on the circuit board.

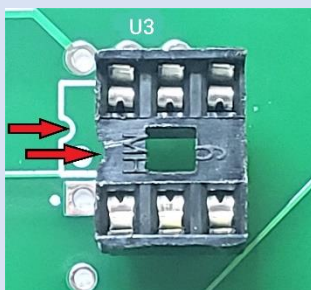

Turn the circuit board over while holding the socket in place, and carefully lay the board down on the work surface. Ensure that all 6 pins are still protruding through the circuit board. Solder one of the pins while ensuring that the socket remains flush with the circuit board. Then solder the remaining 5 pins before moving to the next step.

- 3 Repeat step 2 for the 6-pin IC socket at location **U4**.

- 4 Repeat step 2 for the 6-pin IC socket as location **U5**.



Note: The remaining components on this board all have wire leads. The following tips will help with the placement and soldering of these components:

- The following illustration shows how to “lock” the component in place by slightly bending the leads.

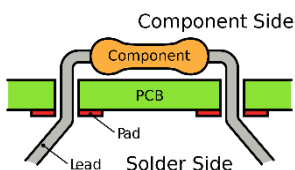

- For the resistors and diodes, use your needle nosed pliers to bend the leads on either side of the component so that they fit the holes provided for that component.
- Trim the leads using your diagonal wire cutters so they only protrude about ½ inch beyond the bottom of the circuit board.
- All components will have their component number printed as close as possible to their outline.
- Where possible, the component’s value will be printed within their outline. If there is no room within the outline, then the value will be printed as close to it as possible.

- 5 Insert each of the 3 **12 Ω ¼ watt resistors (brown / red / black / gold)** at their respective locations: **R7, R8, and R9**. Then solder all 6 leads. Once all leads have been soldered, cut the excess leads flush with the solder joint using your diagonal cutters.



- 6 Insert each of the 6 **330 Ω ¼ watt resistors (orange / orange / brown / gold)** at their respective locations: **R14, R47, R48, R51, R52, and R53**. Then solder all 12 leads. Once all leads have been soldered, cut the excess leads flush with the solder joint using your diagonal cutters.



- 7 Insert each of the 3 **430 Ω ¼ watt resistors (yellow / orange / brown / gold)** at their respective locations: **R1, R2, and R3**. Then solder all 6 leads. Once all leads have been soldered, cut the excess leads flush with the solder joint using your diagonal cutters.



- 8 Insert each of the 11 **1 kΩ ¼ watt resistors (brown / black / red / gold)** at their respective locations: **R16, R19, R20, R23, R24, R27, R28, R31, R33, R34, and R45**. Then solder all 22 leads. Once all leads have been soldered, cut the excess leads flush with the solder joint using your diagonal cutters.



- 9 Insert each of the 3 **3.3 kΩ ¼ watt resistors (Orange / orange / red / gold)** at their respective locations: **R4, R5, and R6**. Then solder all 6 leads. Once all leads have been soldered, cut the excess leads flush with the solder joint using your diagonal cutters.



- 10 Insert each of the 7 **4.7 kΩ ¼ watt resistors (yellow / violet / red / gold)** at their respective locations: **R32, R60, R61, R62, R63, R64, R65**. Then solder all 14 leads. Once all leads have been soldered, cut the excess leads flush with the solder joint using your diagonal cutters.



- 11 Insert each of the 10 **10 kΩ ¼ watt resistors (brown / black / orange / gold)** at their respective locations: **R13, R17, R18, R21, R22, R25, R26, R29, R30, and R70**. Then solder all 20 leads. Once all leads have been soldered, cut the excess leads flush with the solder joint using your diagonal cutters.



12 Insert the **10 Ω 1 watt resistor (brown / black / black / gold)** at **R10**. Then solder both leads. Once the leads have been soldered, cut the excess leads flush with the solder joint using your diagonal cutters.

13 Insert the **15 Ω 1 watt resistor (brown / green / black / gold)** at **R11**. Then solder both leads. Once the leads have been soldered, cut the excess leads flush with the solder joint using your diagonal cutters.

14 Insert the **13 Ω 1 watt resistor (brown / orange / black / gold)** at **R12**. Then solder both leads. Once the leads have been soldered, cut the excess leads flush with the solder joint using your diagonal cutters.

15 Insert each of the 9 **0.1 μ f ceramic disk capacitors** at their respective locations: **C1, C2, C6, C7, C8, C9, C10, C11, and C12**. Then solder all 18 leads. Once all leads have been soldered, cut the excess leads flush with the solder joint using your diagonal cutters.

16 Insert the **0.33 μ f ceramic disk capacitor** at its location **C5**. Then solder both leads. Once they have been soldered, cut the excess leads flush with the solder joint using your diagonal cutters.

17 Insert the **470 μ f electrolytic capacitor** at its location: **C3**.

Important! - Ensure that you observe the polarity of this capacitor. The white stripe on the side of the capacitor's "can" denotes the NEGATIVE lead. Make sure that this lead is placed in the hole closest to the white mark on the circuit board outline.

Then solder both leads. Once all leads have been soldered, cut the excess leads flush with the solder joint using your diagonal cutters.



18 Insert the **100 μ f electrolytic capacitor** at its location: **C4**.

Important! - Ensure that you observe the polarity of this capacitor. The white stripe on the side of the capacitor's "can" denotes the NEGATIVE lead. Make sure that this lead is placed in the hole closest to the white mark on the circuit board outline.

Then solder both leads. Once all leads have been soldered, cut the excess leads flush with the solder joint using your diagonal cutters.

19 Insert each of the 4 **3V Zener diodes** at their respective locations: **D1, D2, D3, and D4**.

Important! - Ensure that the black stripe on each diode aligns with the stripe printed on the circuit board outline.

Then solder all 8 leads. Once all leads have been soldered, cut the excess leads flush with the solder joint using your diagonal cutters.

20 Insert one of the **1N4002 silicon diode** at its location: **D5**.

Important! - Ensure that the white stripe on each diode aligns with the stripe printed on the circuit board outline.

Then solder both leads. Once they have been soldered, cut the excess leads flush with the solder joint using your diagonal cutters.

- 21 Insert each of 3 of the **1N4005 silicon diode** at their respective locations: **D6, D7, and D8**.



Important! - Ensure that the white stripe on each diode aligns with the stripe printed on the circuit board outline.

Then solder all 6 leads. Once they have been soldered, cut the excess leads flush with the solder joint using your diagonal cutters.

- 22 Insert each of the 3 **red 3mm light emitting diodes (LEDs)** at their respective locations **Ant 2 Sel, Ant 3 Sel, and Ant 4 Sel**.



Important! - Ensure that the flat side of the diode aligns with the minus (-) sign printed next to the LED outline. The flat side may be hard to discern, so be advised that the shortest of the two LED leads also corresponds to the negative side of the LED.

Then solder all 6 leads. Once all leads have been soldered, cut the excess leads flush with the solder joint using your diagonal cutters.

- 23 Insert one of the **5001 test rings** at its location: **TP1**. Both leads can be soldered as one. There is no need to cut these leads as they will not protrude very far beyond the bottom of the circuit board.



- 24 Insert the **20 kΩ trimmer resistor** at its location: **R71**. Solder all 3 leads. Once all leads have been soldered, cut the excess leads flush with the solder joint using your diagonal cutters.



- 25 Insert each of the 4 **2N3904 NPN bipolar transistors** at their respective locations: **Q4, Q5, Q6, and Q7**.



Important! - Ensure that the flat side of the transistor aligns with transistor's outline on the circuit board. Also, use as little solder as necessary when soldering each lead as the pads are very close together. Using too much solder may cause short circuits between the leads. After soldering, use a magnifying glass to inspect your work to ensure clean space between the leads.

Note: the transistors will sit approximately 3/32" above the circuit board when properly inserted – this is expected.

Solder all 12 leads. Once all leads have been soldered, cut the excess leads flush with the solder joint using your diagonal cutters.

Note: the next two steps cover the installation of the two 8 pin female headers that will accommodate the optional USB interface daughterboard. If you did not purchase this option, please skip to Step 28.

- 26 Insert one of the 8 pin female headers at the location marked: **H1**.



Turn the circuit board over while holding the header in place, and carefully lay the board down on the work surface. Ensure that the 8 pins are still protruding through the circuit board. The weight of the board should ensure that the connector will remain in place while you solder the pins.

Solder one of the pins while ensuring that the connector remains flush AND perpendicular with the circuit board. Then solder the remaining 7 pins before moving to the next step.

Important Tip: It is much easier to adjust the positioning of the 8-pin header while only one of the pins have been soldered. Make sure that the header is perpendicular to the circuit board as well as aligned with the header's white outline on the surface of the circuit board before soldering the remaining 7 pins. If need be, reheat the solder connection while manipulating the header in position with your other hand.

- 27 Repeat step 26 for the female header at the location marked: **H2**.



End of optional steps

- 28 Insert the male DB-9 socket at the location marked: **J2_BAND_DATA**. You will also have to apply a little pressure to get the metal pins to seat correctly. The pins will hold the socket in place while you solder the 9 pins as well as the 2 locking tabs.



- 29 Insert one of the **14 pin IDC headers** at the location marked: **CN1**.



Important! - Ensure that the notch in the connector aligns with the notch on the printed outline.

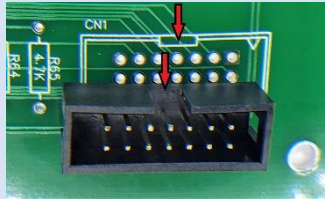

Turn the circuit board over while holding the connector in place, and carefully lay the board down on the work surface. Ensure that the 14 pins are still protruding through the circuit board. The weight of the board should ensure that the connector will remain in place while you solder the pins.

Solder one of the pins while ensuring that the connector remains flush with the circuit board. Then solder the remaining 13 pins before moving to the next step.

- 30 Attach a fuse holder on each end of the ½ Amp fuse as shown in the image to the right. Insert this assembly into the holes provided at the fuse's location (**FH1** and **FH2**) on the circuit board and solder all four tabs.



Note: The fuse and holders are only included in kits with main circuit board version 6.3 or later.

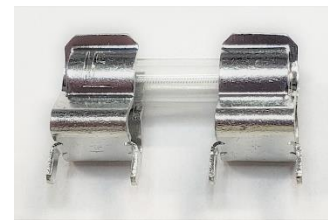

- 31 Insert one of the AC/DC power jacks at the location marked: **J1**.



Turn the circuit board over while holding the socket in place, and carefully lay the board down on the work surface. Ensure that all 3 "pins" are still protruding through the circuit board.

Solder one of the pins while ensuring that the socket remains flush with the circuit board. Then solder the remaining 2 pins before moving to the next step.

- 32 Repeat the previous step for the other AC/DC power jack at the location marked: **J3**.



- 33 Insert the 2-conductor Molex PCB Header in the location marked **CN3**. Orient the header as shown in the image to the right. Solder both pins. No need to cut off the excess as these pins will not protrude far beyond the bottom of the circuit board.



- 34 Solder both leads from one end of the **6" x 2 conductor twisted pair cable assembly** to the **Toggle Switch**. It doesn't matter which color wire goes to which solder lug – just solder one wire to each lug.

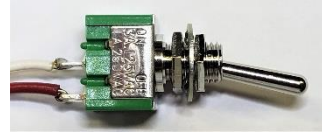

- 35 Insert the 3 **BT139-600E Triacs** at their respective locations: **Q1, Q2, and Q3**. These components should sit about ¼ inch above the circuit board as show in the image to the right.

Important! - Also note the orientation of the metal tabs of each triac aligns with the double line on each component's circuit board outline.

Tip: slightly spread the two outer leads of each transistor prior to inserting into the holes – this will provide some friction that will help keep the case resting above the board.

Solder one of the leads first and check the case's position – adjust as necessary by reheating the solder joint and manipulating the triac's position while heat is applied, and the solder is melted. Once the alignment is correct, solder the remaining 2 leads. Cut off the excess leads using your diagonal cutters.

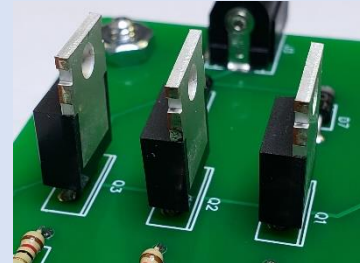

- 36 Insert the **+5V linear voltage regulator** at its location: **U2_5V_REG**. This component should sit about ¼ inch above the circuit board as show in the figure to the right.

Important! - Also note the orientation of the metal tab aligns with the double line on the component's circuit board outline.

Tip: slightly spread the two outer leads prior to inserting into the holes – this will provide some friction that will help keep the case resting above the board.

Solder one of the leads first and check the case's position – adjust as necessary by reheating the solder joint and manipulating the regulator's position while heat is applied, and the solder is melted. Once the alignment is correct, solder the remaining 2 leads. Cut off the excess leads using your diagonal cutters.



- 37 Take time to inspect all the solder connections – preferably with a magnifying glass. Look for connections that may not have enough - or too much - solder. Be especially careful when examining Q4 – Q7 to ensure that there are no solder bridges between any of the three pads associated with each transistor.

Also double-check to ensure that the correct components (especially the resistors) were placed in their respective locations.

Once this final inspection is complete, set the board aside and move to the next section: **Controller Front Panel.**

CONTROLLER FRONT PANEL

Note: Except for the IDC header (CN2) all soldering will be done on the underside of this circuit board.

- 38 Insert the remaining **14 pin IDC header** at the location marked: **CN2**. **Note that this component is placed on the opposite side of the circuit board from the buttons and LEDs.**

Important! - Ensure that the notch in the connector aligns with the notch on the printed outline.

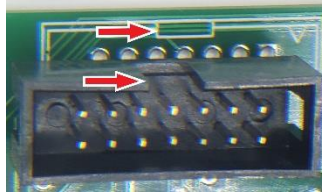

Turn the circuit board over while holding the connector in place, and carefully lay the board down on the work surface. Ensure that the 14 pins are still protruding through the circuit board. The weight of the board should ensure that the connector will remain in place while you solder the pins.

Solder one of the pins while ensuring that the connector remains flush with the circuit board. Then solder the remaining 13 pins before moving to the next step.

- 39 Insert the 4 **TS26 tactile pushbutton switches** at their respective locations: **PB1, PB2, PB3, and PB4**.

Before inserting each switch, inspect its underside and locate the positive side of the switch (+) as well as the small protruding locator “key”. The key should fit into the small hole drilled into the circuit board **above** the plus sign. Refer to the images below for clarification.

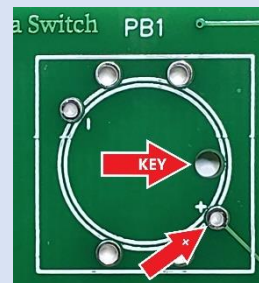
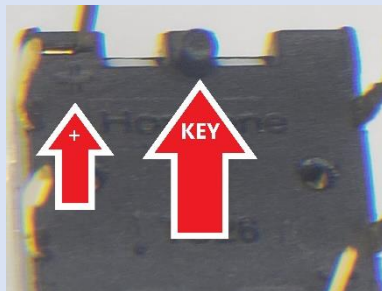

Take care that all the pins line up with the holes in the circuit board before pressing down. It will take slight pressure to seat the switches – there will be a very slight gap between the bottom of the switch and the circuit board – this is expected.

Once all the switches have been inserted, solder all 24 leads then trim them flush with the solder joint using diagonal wire cutters.

- 40 Insert the **TSS tactile pushbutton switch** at its location: **PB5**.
- Like the switches installed in the previous step, inspect its underside, and locate the positive side of the switch (+) as well as the small protruding locator “key”. The key should fit into the small hole drilled into the circuit board between the 2 top solder pads. Refer to the images below for clarification.

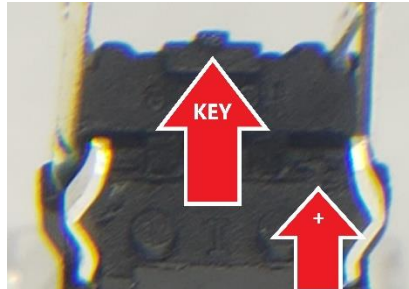

Take care that all the pins line up with the holes in the circuit board before pressing down. It will take slight pressure to seat the switches – there will be a very slight gap between the bottom of the switch and the circuit board – this is expected.

Once all the switches have been inserted, solder all 6 leads then trim them flush with the solder joint using diagonal wire cutters.

- 41 Insert the **5mm green light emitting diode (LED)** at its location: **AUTO**. Ensure that the flat (-) side of the diode aligns with the flat side of the component’s outline on the circuit board. Failure to do this will result in the diode not working. Also, **position the LED so that it is 3/16” above** the circuit board.

Tip: By spreading the leads of the LED apart slightly before inserting them into the holes, you can create enough friction from the side pressure to hold the LED at the desired height above the circuit board.

Once the LED is in place, solder both leads then trim them flush with the solder joint using diagonal wire cutters.

- 42 Insert the **5mm red light emitting diode (LED)** at its location: **MANUAL**. Ensure that the flat (-) side of the diode aligns with the flat side of the component’s outline on the circuit board. Failure to do this will result in the diode not working. Also, **position the LED so that it is 3/16” above** the circuit board.

Tip: By spreading the leads of the LED apart slightly before inserting them into the holes, you can create enough friction from the side pressure to hold the LED at the desired height above the circuit board.

Once the LED is in place, solder both leads then trim them flush with the solder joint using diagonal wire cutters.

- 43 Insert the **5mm yellow light emitting diode (LED)** at its location: **XMIT**. Ensure that the flat (-) side of the diode aligns with the flat side of the component's outline on the circuit board. Failure to do this will result in the diode not working. Also, **position the LED so that it is 3/16" above** the circuit board.

Tip: By spreading the leads of the LED apart slightly before inserting them into the holes, you can create enough friction from the side pressure to hold the LED at the desired height above the circuit board.

Once the LED is in place, solder both leads then trim them flush with the solder joint using diagonal wire cutters.

- 44 Take time to inspect all the solder connections – preferably with a magnifying glass. Look for connections that may not have enough - or too much - solder.
- Double-check to ensure that the correct colored LEDs were placed in their respective locations, and their flat sides match those of their printed outlines on the circuit board.
- Once this final inspection is complete, set the board aside and move to the next section: **Remote Antenna Relay Board**.

REMOTE ANTENNA RELAY BOARD

The following steps have been designed to make it easier to insert the individual relays while keeping the circuit board relatively level while soldering their pins. You will notice that the 3 relays will be installed using 2 successive steps for this purpose.

- 45 Insert the remaining **5001 Test Ring** in the hole marked **TP2** and solder it to the circuit board.

- 46 Insert 2 **DPDT 12V Power Relays** at locations: **K2 and K3**. Carefully turn the circuit board over while holding both relays in place with your fingertips.
- Ensure that all 8 pins for each relay are protruding through the circuit board, then solder one pin for each relay to hold it flush with the circuit board. After inspecting to verify the relays remain flush, solder the remaining 14 pins.

- 47 Insert a **DPDT 12V Power Relays** at location: **K1**. Carefully turn the circuit board over while holding the relay in place with your fingertips.
- Ensure that all 8 pins for the relay are protruding through the circuit board, then solder one pin for to hold it flush with the circuit board. After inspecting to verify the relay remains flush, solder the remaining 7 pins.

- 48 Insert 2 **1N4005 silicon diodes** at their locations: **D1 and D2**.
- Important! - Ensure that the white stripe on each diode aligns with the stripe printed on the circuit board outline.**
- Then solder both leads. Once they have been soldered, cut the excess leads flush with the solder joint using your diagonal cutters.

49 Insert 2 **.01 μf Ceramic Disk Capacitors** at their locations: **C1 and C2**. Then solder all 4 leads. Once all leads have been soldered, cut the excess leads flush with the solder joint using your diagonal cutters.

50 Insert 2 **.0068 μf (6.8 nf) Ceramic Disk Capacitors** at their locations: **C3 and C4**. Then solder all 4 leads. Once all leads have been soldered, cut the excess leads flush with the solder joint using your diagonal cutters.

51 Insert 2 **470 μf Electrolytic Capacitors** at their locations: **C5 and C6**.

Important! - Ensure that you observe the polarity of these capacitors. The white stripe on the side of the capacitor's "can" denotes the NEGATIVE lead. Make sure that this lead is placed in the hole closest to the white mark on the circuit board outline.

Then solder all 4 leads. Once all leads have been soldered, cut the excess leads flush with the solder joint using your diagonal cutters.

52 Insert the **40 μH RF Choke** at its location: **L1**. Then solder both leads. Once all leads have been soldered, cut the excess leads flush with the solder joint using your diagonal cutters.

53 Insert the **18 μH RF Choke** at its location: **L2**. Then solder both leads. Once all leads have been soldered, cut the excess leads flush with the solder joint using your diagonal cutters.

54 Take time to inspect all the solder connections – preferably with a magnifying glass. Look for connections that may not have enough - or too much - solder.

Once this final inspection is complete, set the board aside and proceed to the next section: **Bias-T Board**.

BIAS-T BOARD

55 Insert 2 **.01 μf Ceramic Disk Capacitors** at their locations: **C1 and C2**. Then solder all 4 leads. Once all leads have been soldered, cut the excess leads flush with the solder joint using your diagonal cutters.

56 Insert 2 **.0068 μf (6.8 nf) Ceramic Disk Capacitors** at their locations: **C3 and C4**. Then solder all 4 leads. Once all leads have been soldered, cut the excess leads flush with the solder joint using your diagonal cutters.

57 Insert the **40 μH RF Choke** at its location: **L1**. Then solder both leads. Once all leads have been soldered, cut the excess leads flush with the solder joint using your diagonal cutters.

58 Insert the **18 μH RF Choke** at its location: **L2**. Then solder both leads. Once all leads have been soldered, cut the excess leads flush with the solder joint using your diagonal cutters.

- 59 Take time to inspect all the solder connections – preferably with a magnifying glass. Look for connections that may not have enough - or too much - solder.



Once this final inspection is complete, set the board aside and proceed to the next section: ***Final Assembly***.

FINAL ASSEMBLY

CONTROLLER

FRONT PANEL

The front panel circuit board is mounted to the front panel using 2 threaded standoffs. The buttons and LEDs contained on the front side of the circuit board are designed to fit through the cutouts provided in the prepared enclosure.

- 60 Insert the male end of two 4-40 X 3/8" standoffs into the holes provided on either side of the front panel circuit board – insert it from the front side (contains the buttons and LEDs) of the circuit board and secure them with 4-40 hex nuts.
- 61 Plug one end of the 14-conductor ribbon cable assembly into its IDC header on the front panel circuit board.
Note the connector "key" - the connector will only fit one way, and it doesn't matter which end attaches to the circuit board.
- 62 Mount the front panel circuit board using a 4-40 x 1/4" pan head screw at each standoff.

MAIN BOARD

The main circuit board is mounted using 4 threaded standoffs. The three rear-mounted connectors are designed to fit through the cutouts and should end up flush with the rear panel.

- 63 Insert the male end of four 6-32 X 3/8" standoffs into the holes provided on each corner of the main circuit board – insert it from the bottom of the circuit board and secure them with 6-32 hex nuts.
- 64 If you purchased the optional USB interface, align the pins on the bottom of the daughterboard with the headers installed in steps 26 and 27 and gently press down until the pins are fully inserted into the headers. The daughterboard should be oriented as shown in the top image to the right:

Important! – Please check to make sure that the jumper next to the 20-pin microcontroller is set to short the two RAAS-4 pins as shown in the bottom image to the right:

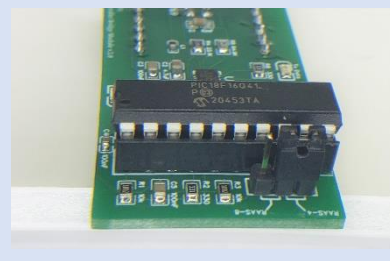
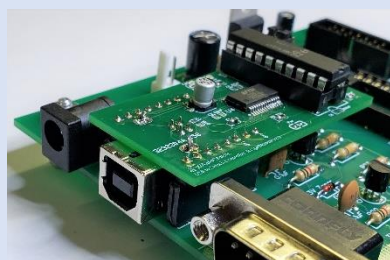

- 65 Mount the main circuit board using a 6-32 x ¼" pan head screw at each standoff.



POWER SWITCH AND RIBBON CABLES

- 66 Prepare the Toggle switch by removing the outer nut and the lock washer and position the inner nut about halfway down the threaded collar as shown in the image to the right.

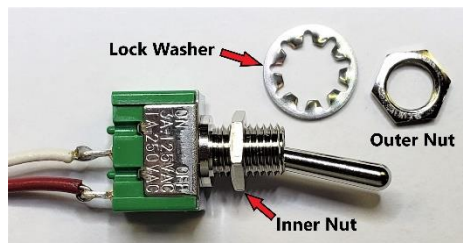

- 67 Insert the switch into the ¼" front panel hole aligned as shown in the image to the right. Make sure that the "On" position is pointing up.



Secure it by first placing the lock washer on the collar, then screw and tighten the outer nut while holding the body of the switch to prevent twisting.

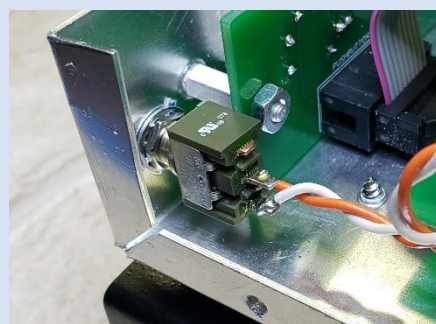

- 68 Plug the toggle switch's connector into its socket (CN3) located on the main circuit board. The connector will only fit when oriented such that the "key" fits in the "U" shaped cutout in the socket.



- 69 Plug the free end of the 14-conductor ribbon cable assembly into its IDC header on the main circuit board.



Note the connector "key" - the connector will only fit one way.

Please refer to the image on the right for the proper placement of the ribbon cable assembly.

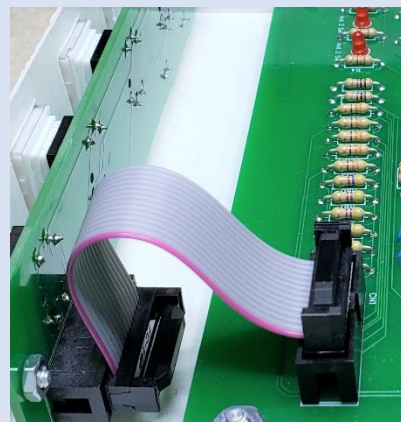

- 70 Install the 4 peel-and-stick rubber feet that are provided with the enclosure.



ADJUST ICOM BAND DATA VOLTAGE DIVIDER

The following steps will guide you through the adjustment of the voltage divider that will reduce the Icom band data voltage presented at the rear connector by one half. This is needed so that the resulting voltage will stay within the PIC Microcontroller's measurement window.

Note that the PIC Microcontroller has not been installed at this point. It will be installed as the final assembly step in the next section.

- 71 Connect one end of the **19" Alligator clip jumper wire** to the end of resistor R70 and the other end to the end of resistor R30 as shown in the image below.

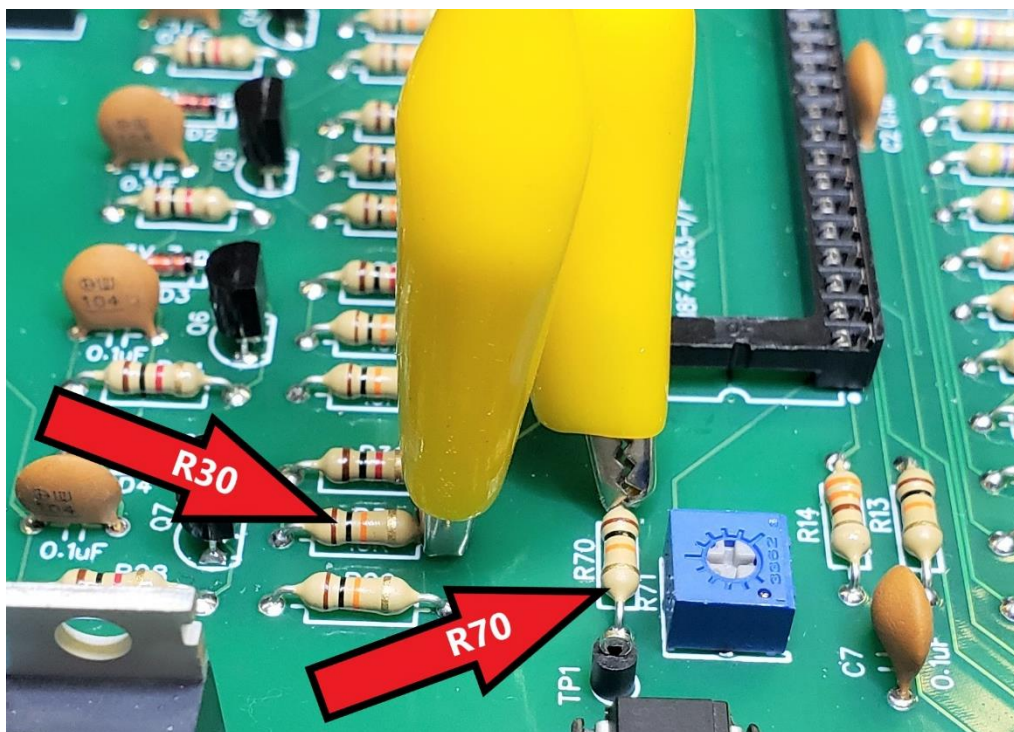

- 72 Connect the negative lead from the multimeter to the metal controller case. Connect the positive lead to the alligator clip at resistor R30. Set the multimeter so that it will measure DC voltage – approximately +5 VDC.
- 73 Plug the 12V AC Wall Power Supply into a 110V AC wall socket and the other end into the 12 VAC power jack on the rear panel of the antenna controller. Flip the front panel power switch to the "On" position.
- 74 Record the voltage reading from the multimeter. It should be +5V ($\pm 0.1V$).
- Divide your reading by 2 – **this is the target voltage.**

- 75 Move the multimeter's positive lead to TP1 and very slowly turn R71's grey adjustment "knob" using a small screwdriver so that the multimeter reads the target voltage calculated in the previous step. You may need to go back and forth on your adjustment before zeroing in on the target voltage. Refer to the image below for visual guidance.

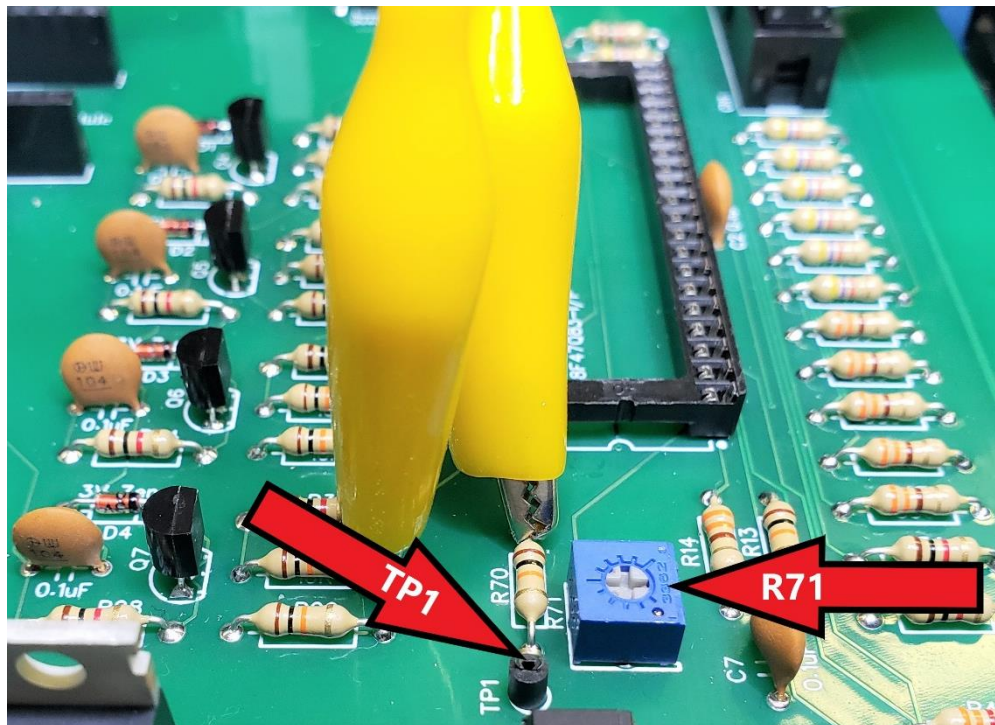

- 76 Flip the front panel power switch to the "Off" position and unplug the power supply. **Remove the multimeter test leads as well as the alligator clip jumper.**
This concludes the voltage divider adjustment procedure. Proceed to the next controller assembly section: **Install the three MOC3063 Opto-Coupler chips.**

INSTALL THE THREE MOC3063 OPTO-COUPLER CHIPS

The three opto-couplers isolate the 12VAC switching voltage from the rest of the controller's circuitry by using an internal LED to turn on the appropriate Triac. It is possible to install these chips backwards, so please pay close attention to the instructions in the following installation steps.

- 77 Orient one of the **MOC3063 Opto-Coupler chips** so that the small dot on the corner of the chip is on the left front in relation to the controller circuit board as shown in the image below.

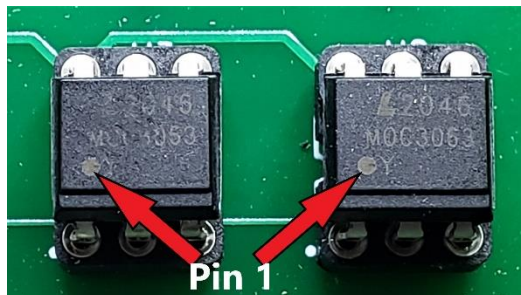

- 78 The pins of a new opto-coupler chip are spread apart further than the socket's receptacles, so you will need to gently use your fingers to squeeze the two sides together until all the pins line up with their receptacle. This should be an iterative process where you squeeze the pins together a small amount and test the fit, then repeat if the fit is still not perfect.

Once all the pins line up with their respective receptacle in the IC socket, place the chip on top of the socket ensuring that the pin 1 dot is aligned correctly as detailed in step 77 and proceed to the next step.

- 79 Starting with socket U3, **gently** push down on the chip to ease the pins into their receptacles. If the pins have been aligned correctly, they should slide into the socket without the need for too much pressure.

CAUTION: Be very careful not to bend any pins!

- 80 Repeat the previous three steps for the opto-couplers at sockets U4 and U5.

- This concludes the MOC3063 Opto-Coupler installation procedure. Please proceed to the final controller assembly section: **Install PIC Microcontroller Chip.**

INSTALL PIC MICROCONTROLLER CHIP

The PIC microcontroller contains the computer code (firmware) that controls the operation of the antenna switch. It is possible to install the chip backwards, so please pay close attention to the instructions in the following installation steps.

- 81 Orient the PIC Microcontroller chip so that the small semi-circular indentation on the end of the chip is pointing in the same direction as the corresponding notch cut into the end of the socket.

- 82 The pins of a new Microcontroller chip are spread apart further than the socket's receptacles, so you will need to gently use your fingers to squeeze the two sides together until all the pins line up with their receptacle. This should be an iterative process where you squeeze the pins together a small amount and test the fit, then repeat if the fit is still not perfect.

Once all the pins line up with their respective receptacle in the IC socket, place the chip on top of the socket ensuring that the semi-circular indentation is aligned correctly as detailed in step 81 and proceed to the next step.

- 83 **Gently** push down on the chip to ease the pins into their receptacles. If the pins have been aligned correctly, they should slide into the socket without the need for very much pressure.

CAUTION: Be very careful not to bend any pins!

The following image shows the installed chip in its correct alignment (note: the chip's version number will vary):



- 84 This completes the assembly of the antenna switch's controller unit.
- The controller enclosure's cover will be installed AFTER initial testing has been completed.
- Please proceed to the next section: **Remote Antenna Relay Box**

REMOTE ANTENNA RELAY BOX

The final assembly of the remote antenna relay box consists of installing the five SO-239 coax connectors, then mounting the circuit board to the underside of the enclosure's cover plate. Once the circuit board has been properly fitted, the (4) 100KΩ resistors are installed.

MOUNTING THE CIRCUIT BOARD

The relay box circuit board is mounted relay-side up on the underside of the enclosure's cover plate. A 5.5mm hole in the circuit board will line up with the M5 x .80 x 10mm standoff to support the circuit board. Likewise, the center conductors of the five SO-239 Coax connectors will protrude through their respective holes in the circuit board. Once the standoff is secured using a hex nut and the center conductors are soldered, the circuit board will be securely attached. The following steps provide details on how to mount the circuit board.

- 85 Install the M5 x .80 x 10+7mm standoffs in the 5.5mm hole using an M5 x .80 pan head stainless steel machine screw. The standoff should be mounted to the underside of the cover plate. **Do not tighten the screw yet.**
- 86 Install the (5) SO-239 coax connectors by inserting them through the top side of the cover plate into each of the (5) 5/8" holes. Secure them with the washer and nut provided with each connector. Once again, **do not tighten the nuts yet.**

- 87 Set the cover plate on the work surface with the underside facing up – it will be supported by the coax connectors. Align the circuit board's 5.5mm hole with the standoff and attempt to push the board onto the standoff while ensuring the center conductors of the five coax connectors mate with their respective circuit board holes. You may have to "wiggle" the standoff to get it to align with the circuit board hole. Likewise, if the coax connectors do not line up exactly, you may be able to adjust the alignment by slightly rotating each connector until its center conductor fits through the hole.



- 88 With the circuit board in place, tighten the screw securing the standoff so it will not change position.

Note: DO NOT use the nut to secure the circuit board to the standoff yet.

- 89 Note that the end of each coax connector's center pin is shaped like a semi-circle. Note the angular position of each semi-circle – this is to ensure the connectors do not rotate while tightening their nuts.



- 90 Carefully remove the circuit board and set it aside for now.

- 91 Attach a PL-259 connector to one of the coax connectors as shown in the figure to the right to provide a better grip while tightening the connector's nut. Use a pair of pliers to ensure a tight grip while tightening the nut with a 3/4" socket.

NOTE: ensure that the connector doesn't rotate while tightening the nut, or you may not be able to fit the circuit board back in place.

Repeat for each of the remaining 4 connectors.



- 92 Carefully re-fit the circuit board. If any of the coax connectors no longer fit into their respective holes, loosen the nut for that connector and slightly rotate it to its original position and retry the fit. Once the circuit board is fully in place and sitting flush against the shoulder of the standoff, proceed to the next step.

- 93 Form the 14/16-gauge #10 ring terminal as shown in the image to the right. Be sure that the barrel's seam is facing down before bending it upward.



- 94 Place the ring terminal on the standoff as shown and secure it with an M5 x .80 hex nut. Tighten the nut.



- 95 Proceed to the next section for instructions on installing the (4) 100kΩ 2W Metal Oxide resistors.

INSTALLING THE 100KΩ RESISTORS

- 96 Cut one lead of each of 2 of the 100KΩ 2W Metal Oxide resistors to about 1/2" – leave each resistor's other lead at its original length. Likewise, leave both leads of the other two 100KΩ 2W Metal Oxide resistors at their original length.

Insert the shorter leads of the two modified resistors as well as the leads of the untouched resistors into the barrel of the ring terminal as shown in the image to the right. Arrange the 4 resistors as shown and solder them in place.



Note: Depending on your soldering iron's power, you may have to hold it in place for some time before the ring terminal's barrel reaches the appropriate temperature for soldering.

Caution: Do NOT allow the soldering iron's tip to get too close to either of the relays. Their cases are made of plastic and WILL melt easily.

- 97 Carefully solder the center conductor of the Input Coax Connector as shown in the image to the right:

Caution: Do NOT allow the soldering iron's tip to get too close to the relay. Its case is made of plastic and WILL melt easily.



- 98 Place one of each of the free leads of the (4) **100KΩ 2W Metal Oxide resistors** into each of the antenna center conductors, and arrange the resistors as shown in the image to the right.

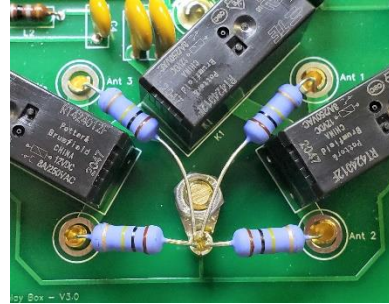

- 99 Carefully solder the resistor lead at the Antenna 2 center conductor as well as the rest of the center conductor to the circuit board as shown in the image to the right:

Caution: Do NOT allow the soldering iron's tip to get too close to any of the relays. Their cases are made of plastic and WILL melt easily.



- 100 Repeat the previous step for the remaining 3 **100KΩ 2W Metal Oxide resistors** and center conductors of their respective antenna connectors (ANT 1, ANT 3, and ANT 4).

- 101 This completes the Antenna Relay Box's assembly. The relay box's cover will be installed AFTER initial testing is completed. Proceed to the next section: **Bias-T Box**.

BIAS-T BOX

The final assembly of the Bias-T box consists of installing the two SO-239 coax connectors as well as the power socket that will receive the cable from the switch controller, then mounting the circuit board. Finally, the center conductors of the two coax connectors will be soldered to the circuit board.

INSTALLING THE CONNECTORS

- 102 Install the (2) SO-239 coax connectors by inserting them through each of the (2) 5/8" holes on each side of the bias-T box. Secure them with the washer and nut provided with each connector. Do not tighten the nuts yet.

- 103 Prepare the AC/DC Panel Mounted Power Jack by first cutting a 1 3/8" piece of the #24 brown hookup wire, and strip 3/8" of insulation from one end and 1/4" of insulation from the other end. Likewise, cut a 1" piece of the #24 red hookup wire, and strip 1/4" of insulation from each end.



- 104 Solder the 3/8"-stripped end of the brown hook-up wire to both of the ground terminals of the Power Jack as shown in the image to the right.



- 105 Solder one end of the 1" piece of red hook-up wire to the center conductor terminal of the Power Jack as shown in the image to the right.



- 106 Remove the AC/DC Panel Mounted Power Jack's mounting nut, then install the jack by inserting it through the 12mm hole labeled "Controller" on the side of the bias-T box. Secure it with the nut that you just removed. Orient the jack as shown in the images to the right.

Caution: Be careful not to tighten the nut too much as the body of the jack is plastic and you can easily strip the threads.



MOUNTING THE CIRCUIT BOARD

- 107 Insert the male end of two 4-40 X 1/2" standoffs into the holes provided on the Bias-T circuit board – insert them from the bottom of the circuit board and secure them with 4-40 hex nuts.

- 108 Slide the circuit board into the Bias-T enclosure so that the two edge cutouts are at the SO-239 end of the enclosure as shown below:

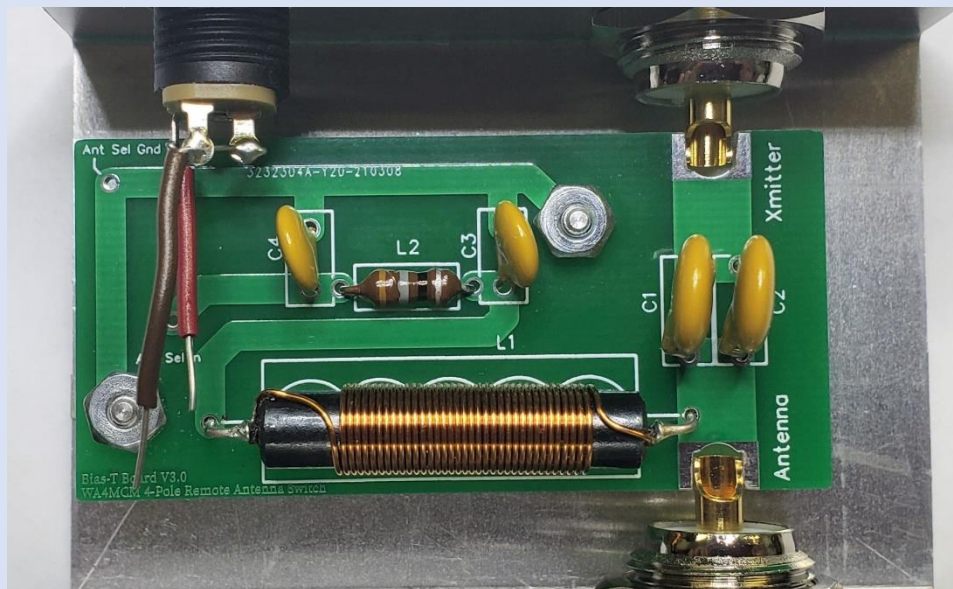

The circuit board should fit around the center conductors as shown in the closeup images below. Rotate the SO-239 Connectors so that the solder cups of the center conductors are pointing up as shown.

Note: it may be necessary to use a small jewelers file to widen the cutouts slightly in order to achieve a good fit. The fit should not be snug, but there shouldn't be more than a .25mm gap between the center conductor and the circuit board material.



- 109 Secure the circuit board to the enclosure using (2) 4-40 x 1/4" screws. Tighten the screws.



- 110 Solder both SO-239 center conductors to the circuit board. The end result should look similar to the image below:



Tip: Make sure that the tip of your soldering iron is touching both the center conductor as well as the solder pad on the circuit board so that BOTH are heated at the same time. This will help achieve solder flow. Also, hold the tip to the underside of the circuit board as well so that the solder will flow all around the center conductor to ensure a solid joint.

- 111 Similar to what was done on the Remote Relay Box in step 91, Attach a PL-259 connector to the SO-239 connector on the Antenna side of the enclosure as shown in the figure to the right to provide a better grip while tightening the connector's nut. Use a pair of pliers to ensure a tight grip while tightening the nut with a 3/4" open-end wrench.

NOTE: ensure that the connector doesn't rotate while tightening the nut, or you run the risk of damaging the solder connection.

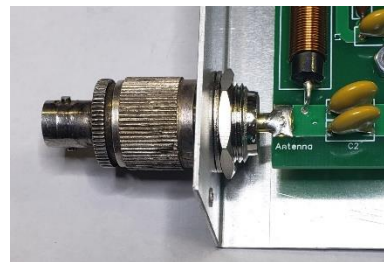

- 112 Repeat the previous step with the SO-239 connector on the Transmitter side of the enclosure.

- 113 Place the free ends of the red and brown hookup wires attached to the AC/DC Panel Mounted Power Jack into their respective holes on the circuit board as shown below. The red wire should go in the hole marked "Ant Sel In", and the brown wire should go in the hole marked "Ant Sel Gnd".

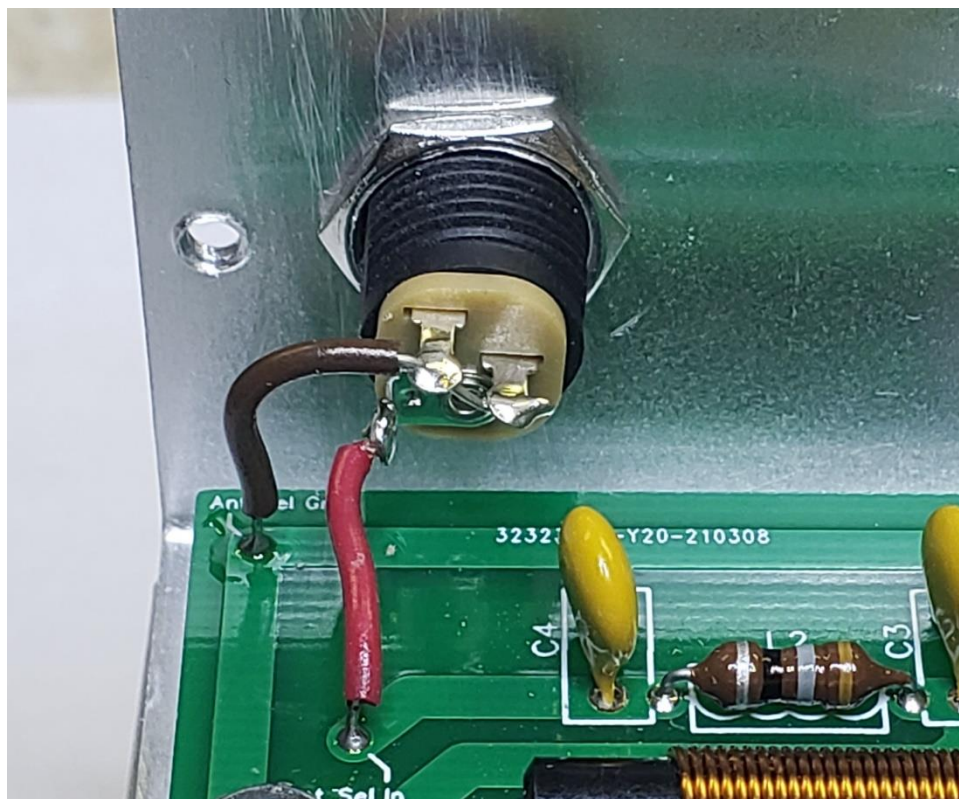

Allow enough space between the circuit board and each wire's insulation to allow the tip of your soldering iron to touch both the bare wire and the circuit board solder pad.

- 114 Solder both the red and brown wires taking care not to melt the insulation too much.
- 115 Slide the Bias-T box's cover into place and secure it with the 4 provided screws.
- Please proceed to the next section: ***Building the interface cable.***

BUILDING THE INTERFACE CABLE

- 116 Begin by carefully stripping 1/2" of the outer jacket from one end of the 4 ft piece of controller interface cable.



Cautionary Tip: This can be done with a razor knife, but be very careful NOT to cut all the way through the jacket – once the jacket has been sufficiently scored by the knife, bending it sharply will cause the jacket to break the rest of the way. This will prevent cutting the very fine shield wires underneath the outer jacket.

- 117 Strip all but 1/8" of insulation from the cable's center conductor.

- 118 Gather and twist the shield's wires together, then twist the center conductor's wires together. The cable end should look similar to the image below:



- 119 Use your soldering iron to “tin” both the shield and center conductor, then trim all but 1/8” of each. The end result should look similar to the image below:



Tip: If you are new to soldering and don't know how to tin multi-conductor wires, please follow [this link for a short informative video](#) on the procedure.

- 120 Slide the backshell of one of the controller interface connectors onto the cable so that its threaded end will mate with the threads of the connector once the cable's conductors have been placed and soldered.



- 121 Insert the shield into the hole in the longer terminal of the connector, and the center conductor into the hole of the shorter terminal as shown in the image below:

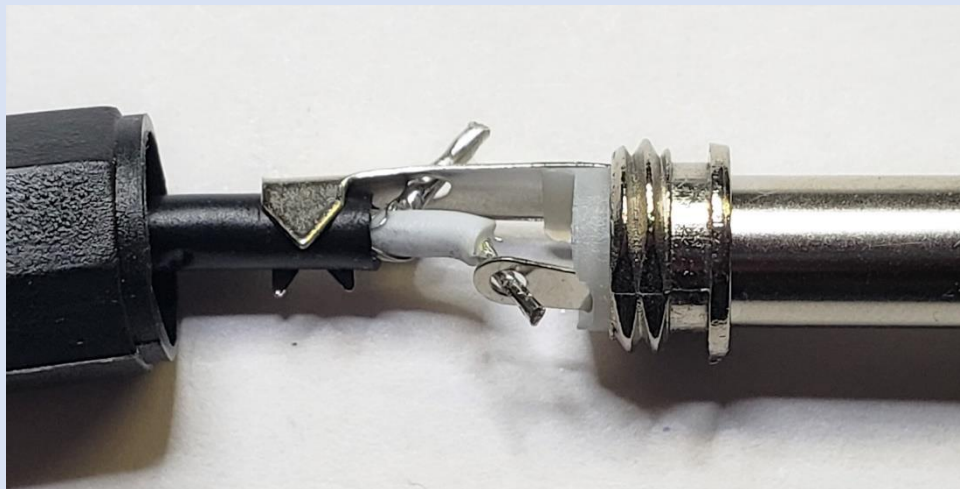

- 122 Solder both conductors being careful not to apply too much heat. The end result should look similar to the images below:

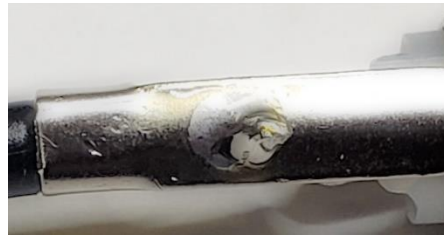
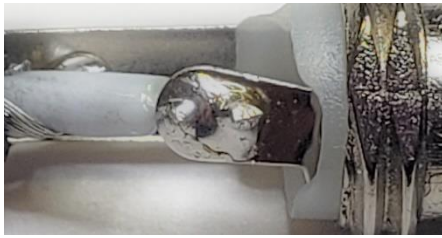

- 123 Use a pair of needle-nosed pliers to bend the strain relief tabs around the cable's jacket as shown in the image below:

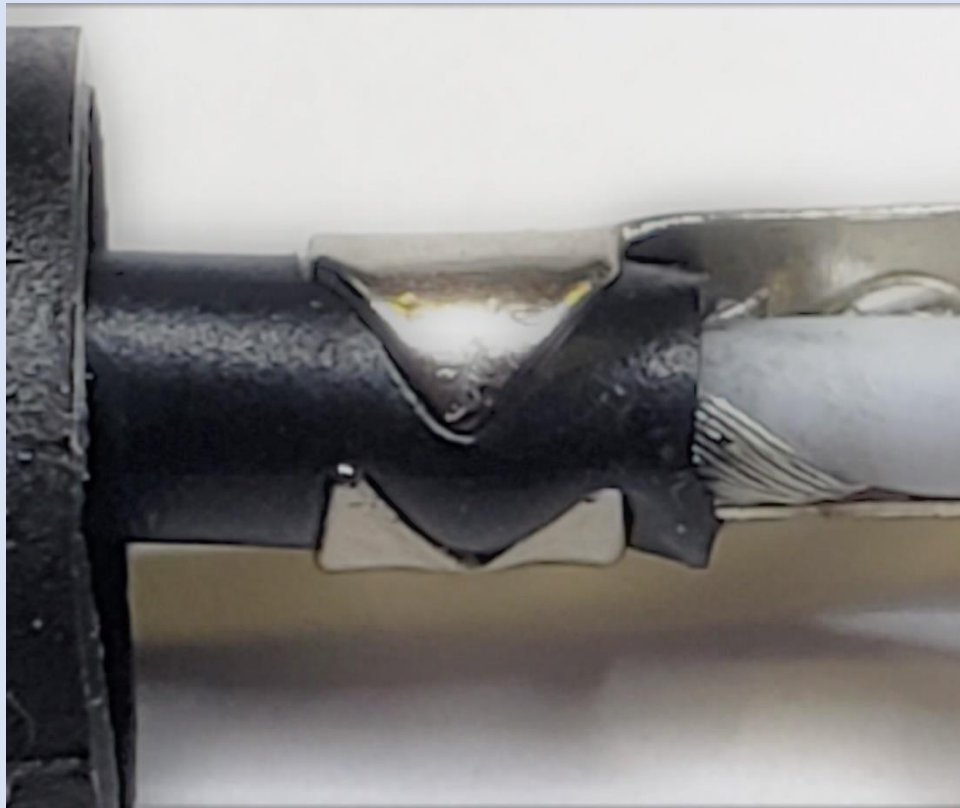

- 124 Slide the connector's backshell towards the connector and screw it onto the connector's threads.



- 125 Repeat the previous 9 steps for the other end of the controller interface cable.



Caution: Be sure to slide the backshell onto the cable BEFORE inserting the conductors into the holes on the connector's terminals!

- 126 This completes the Bias-T Box's assembly. Proceed to the next section: **Testing**.



TESTING

Before testing can begin, you will need to fabricate or obtain a short length (3 ft or less) of 50Ω coaxial cable with PL259 UHF connectors on each end. If you intend to use the antenna switch in automatic mode, you will also need to make the band data cable to interface with your transceiver. Guidance for making the band data interface cable is contained in the antenna switch's Operation Manual.

Connect the components of the switch together as shown below in Figure 4. There is no need to connect the transmitter RF output to the Bias-T box at this time.

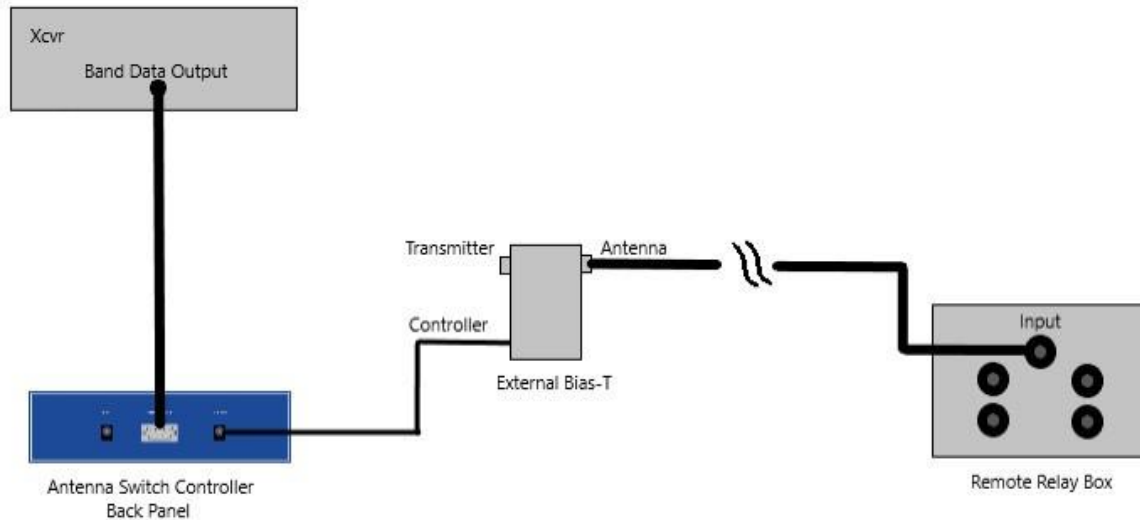

Figure 4 - Initial Testing Hookup

If any of the tests listed below fail, proceed to the troubleshooting section for help.

MANUAL MODE

Manual mode testing starts with selecting each antenna in turn and confirming that the correct antenna (and only that antenna) has been switched on at the remote relay box. Please note that the remote relay box's cover has yet to be attached to the enclosure's body so that your multimeter leads may reach TP2 on the relay box's circuit board.

- 127 Plug the 12VAC power supply into a suitable 110V AC wall socket, then plug the other end into the controller's back panel power jack.
- 128 Turn the controller on by flipping the front panel toggle switch to the "On" position.
 Carefully observe that there is no smoke or odors that would indicate any components are overheating.
- 129 Observe that the Ant 1 button lights up as the default selected antenna.
 Also observe that the red Manual Mode LED is illuminated.

130 Using a multimeter set to read continuity (use the resistance mode if your multimeter doesn't have a continuity mode), connect one lead to **TP2** on the Remote Relay Box circuit board and the other lead to the center conductor of the **Ant 1** connector. There should be continuity (close to 0 Ω resistance).

131 While keeping the one lead on **TP2**, touch the other lead to the center conductor of each of the other 3 antenna connectors to ensure that there is **no** continuity (or, greater than 150KΩ if using the meter's resistance setting).

132 On the controller's front panel, press the Ant 2 button and observe that it illuminates. Also observe that, on the controller's main board, LED **Ant 2 Sel** illuminates and both LED **Ant 3 Sel** and LED **Ant 4 Sel** are not illuminated.

133 Repeat step 130 – except place the multimeter leads between **TP2** and **Ant 2** connectors

134 Repeat step 131 to confirm **no** continuity (or, greater than 150KΩ if using the meter's resistance setting) between the Input connector and the other 3 antenna connectors.

135 Repeat the previous 3 steps for the remaining 2 antennas. Table 5 below provides the correct status of the main board LEDs:

Table 5 - Antenna Selection Output LEDs

| Selected Antenna | Ant 2 Sel | Ant 3 Sel | Ant 4 Sel |
|------------------|-----------|-----------|-----------|
| Ant 1 | Off | Off | Off |
| Ant 2 | On | Off | Off |
| Ant 3 | Off | On | Off |
| Ant 4 | Off | Off | On |

136 Press and release the Mode button. Observe that all 4 front panel antenna buttons flash on and off quickly.
Also observe that the green Auto Mode LED illuminates.

137 This concludes the Manual Mode testing. Turn off the controller by flipping the front panel toggle switch to the "Off" position.

138 Install the controller enclosure's cover using the sheet metal screws supplied with the case.
Be careful not to tighten the screws too much as it is easy to strip the aluminum.

139 Install the remote relay box's cover on the enclosure's case using the 4 countersunk screws

140 If you intend to use the Auto Mode, please proceed to the next section: **Auto Mode**

AUTO MODE

Auto Mode testing consists of stepping through all the frequency bands available to your transceiver and ensuring that each band can be assigned a different antenna.

- 141 Connect the band data cable between the antenna switch controller and the appropriate interface jack on your transceiver and turn your transceiver on.



- 142 Turn on the antenna controller by flipping the front panel toggle switch to the “On” position.



Observe that the four antenna buttons illuminate one at a time sequentially from left to right. This indicates that the controller is getting band data from the transceiver.

- 143 On your transceiver, select the lowest band available – probably 160 meters, but it doesn’t matter.



- 144 Press and hold the Ant 1 button until it illuminates – it should take about 2 seconds.



- 145 On your transceiver, select the next available band. The buttons should start their sequential flashing again.



- 146 Press and hold the Ant 2 button until it illuminates.



- 147 Repeat the previous two steps for the remaining bands available on your transceiver - except press the next available button in order until all four buttons have been assigned to a band.



Most transceivers will have more the four bands available. Once you have assigned the four buttons, start over with Ant 1, Ant 2, etc. until all the bands have been assigned to a button.

Note: It’s OK to assign more than one band to an antenna. In fact, this is a required feature needed for multi-band antennas.

- 148 Turn the antenna switch controller off and proceed to the next section: **Remote Relay Box**



REMOTE RELAY BOX

The remote relay box will be tested for proper operation under an RF load. You will need a dummy load as well as an SWR meter to perform these tests.

- 149 If your transceiver has a built in SWR meter, connect a length of 50Ω coaxial cable between the transceiver and the Input connector on the remote relay box.



If not, then connect the cable from your transceiver to the input connector on your SWR meter, then connect another length of coax from the SWR meter’s output connector to the Input connector on the remote relay box.

150 Connect a dummy load rated for your transceiver's power output to the Ant 1 connector on the remote relay box.



151 Turn the antenna switch controller on by flipping the front panel toggle switch to the "On" position.



152 Put the antenna switch into manual mode by pressing and releasing the mode button to make the red manual mode LED illuminate.



Select Antenna 1 by pressing the Ant 1 button.

153 Set your transceiver to transmit on its highest frequency band.



Set the transceiver to a mode that will transmit a steady carrier – either use its "tune" function, or CW.

154 Transmit a signal and check the SWR. The SWR should be better than 1.2:1.



Also, if you have a band data interface cable installed, observe that the antenna controller's front panel yellow XMIT LED illuminates when the transmitter is on.

155 Repeat the previous step for the other 3 antenna connectors:



Move the dummy load to the next antenna connector and select that antenna from the antenna controller's front panel buttons.

156 This concludes the testing. You can now deploy the remote switch box.





TROUBLESHOOTING

Before reviewing Table 6 below for possible solutions to your problem, please take time to inspect the following items carefully and thoroughly:

- **Solder Joints** – Bad solder joints are the single most common cause of non-working electronics projects.
- **Correct diode polarity** – Make sure that the white band is pointing in the correct direction. For LEDs, ensure that the flat side of the LED is matching the image on the circuit board.
- **Correct transistor placement** – Ensure that the transistor cases match their outlines on the circuit board. For the 2N3904 transistors, this means the flat side matches.
- **Correct voltage regulator placement** – Ensure the “tab” matches with the double line on the circuit board outline.
- **Microcontroller is installed correctly** – Ensure that the notch is facing in the correct direction.
- **Triacs have been installed correctly** – Ensure that the “tab” matches with the double line on the circuit board.
- **Optocouplers (U3, U4, U5) have been installed correctly** – Ensure that the pin 1 dot is facing in the correct direction.
- **Interface cables are made correctly** – use a multimeter to ensure the cables have continuity from end to end. For the band data cable, ensure that the pins are configured according to the drawings for your specific radio.

When reviewing the possible solutions in Table 6, all measurements are made between the point named in the text and chassis ground unless otherwise noted in the text.

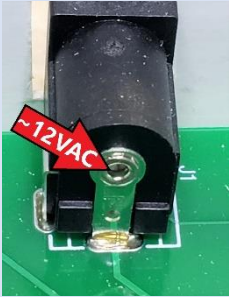
Table 6 - Troubleshooting Matrix

| Symptom | Possible Solutions | |
|--|--|--|
| <p>No LEDs illuminate</p> <p>Antenna controller appears to be dead</p> | <p>Check for:</p> <ul style="list-style-type: none"> About 12VAC between the rear of the power jack J1 and chassis ground:  <p>Note: this measurement can be between 12 and 13.5 VAC.</p> | <p>If measurement is bad:</p> <ul style="list-style-type: none"> Not plugged in or no power at wall outlet Faulty wall adapter |
| | <ul style="list-style-type: none"> ~5VDC between the output of the 5V linear regulator and chassis ground.  <ul style="list-style-type: none"> If incorrect voltage, check for approximately 17VDC on the input pin. | <ul style="list-style-type: none"> If there is not 17V on the input pin, then there is a faulty solder joint, or the front panel on/off switch cable/jack is faulty. If there is 12V on the input pin, then U2 (LM7805) is faulty. |
| <p>No LEDs illuminate</p> <p>Antenna controller appears to be dead (continued)</p> | <p>Check for:</p> <ul style="list-style-type: none"> Check to see if the microcontroller is getting power: 5 vdc between pin 11 and chassis ground. | <p>If measurement is bad:</p> <ul style="list-style-type: none"> Bad solder joint in the circuit path between the 5V linear regulator (U2_5V_REG) and pin 11 of the microcontroller. |
| | <ul style="list-style-type: none"> Check to see if the microcontroller is running by observing the chip's clock on pin 13 of U1 with an oscilloscope. It should be an 8 MHz sine wave. | <ul style="list-style-type: none"> Microcontroller in backwards Bad solder connection on the chip socket Bad 8MHz crystal Bad Microcontroller |

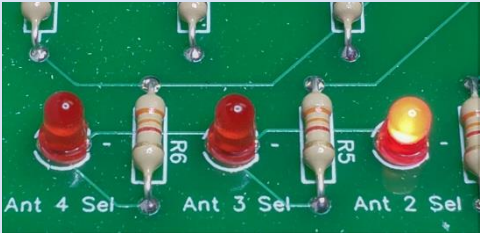
| | | |
|---|---|---|
| <p>The wrong antenna is selected at the remote relay box.</p> | <p>Check for:</p> <ul style="list-style-type: none"> Are the Ant 2 Sel, Ant 3 Sel, and Ant 4 Sel LEDs showing the correct pattern as detailed in Table 5 - Antenna Selection Output LEDs? | <p>If measurement is bad:</p> <ul style="list-style-type: none"> If Ant 2 Sel should be illuminated, but isn't, possible bad solder connection between pin 3 of the microcontroller (U1) and R4. If Ant 3 Sel should be illuminated, but isn't, possible bad solder connection between pin 4 of the microcontroller (U1) and R5. If Ant 3 Sel should be illuminated, but isn't, possible bad solder connection between pin 5 of the microcontroller (U1) and R6. |
| |  <ul style="list-style-type: none"> If the LEDs are correct, use a multimeter to check the voltage between ground (the chassis) and the cathode (banded end) of diode D7 on the controller's main board. The voltages for each selected antenna are as follows: <ul style="list-style-type: none"> Ant 1: close to 0 volts DC or AC Ant 2: between 11 and 13 VDC Ant 3: between -11 and -13 VDC Ant 4: between 11 and 12 VAC <p>Note: The Ant 4 voltage is an AC voltage – you will need to change your multimeter's setting to read it.</p> <p>Also Note: The antenna switch must be fully interconnected before making these measurements – that includes the control cable to the Bias-T box as well as coaxial cable between the Bias-T box and the remote relay box.</p> | <ul style="list-style-type: none"> If you are reading more than a 30-40 mV when Ant 1 is selected, then one or more of the Triacs (Q1, Q2, Q3) are shorted. If the voltage is wrong when Ant 2 is selected Triac Q1 is faulty. If the voltage is wrong when Ant 3 is selected Triac Q2 is faulty. If the voltage is wrong when Ant 4 is selected Triac Q3 is faulty. |
| | <ul style="list-style-type: none"> On the remote relay box circuit board, connect your multimeter's common (Lo) lead to the solder lug attached to the standoff. Refer to the following table for the expected voltage readings: <ul style="list-style-type: none"> Ant 1 <ul style="list-style-type: none"> Diode D1 Anode: close to 0 volts DC Diode D2 Cathode: close to 0 volts DC Ant 2 | <ul style="list-style-type: none"> If the voltages are not present for any selected antenna <ul style="list-style-type: none"> Possible bad control cable between controller and Bias-T box Possible bad solder joint in the Bias-T box's filter (L1, L2) section Possible bad coaxial cable run between Bias-T box and remote relay box. |

| Symptom | Possible Solutions | |
|--|--|---|
| | <ul style="list-style-type: none"> ▪ Diode D1 Anode: close to 0 volts DC ▪ Diode D2 Cathode: between 11 and 13 volts DC ○ Ant 3 <ul style="list-style-type: none"> ▪ D1 Anode: between -11 and -13 volts DC ▪ D2 Cathode: close to 0 volts DC ○ Ant 4 <ul style="list-style-type: none"> ▪ D1 Anode: between -11 and -13 volts DC ▪ D2 Cathode: between 11 and 13 volts DC | <ul style="list-style-type: none"> ○ Possible bad solder joint in the remote relay box's filter (L1, L2) section • If bad voltage at the anode of D1: <ul style="list-style-type: none"> ○ Bad diode D1 ○ Bad capacitor C5 • If bad voltage at the cathode of D2: <ul style="list-style-type: none"> ○ Bad diode D2 ○ Bad capacitor C6 |
| <p>The mode doesn't change when pushing the front panel mode button.</p> | <p>Check for:</p> <ul style="list-style-type: none"> • +5 vdc on pin 1 of the mode switch:  <ul style="list-style-type: none"> • +5 vdc on U1 pin 37 when the mode button is depressed. | <p>If measurement is bad:</p> <ul style="list-style-type: none"> • Bad solder joint in the circuit path between the 5V linear regulator (U2) and pin 1 of the mode switch. • Faulty ribbon cable between main circuit board and front panel. • Bad solder joint in the circuit path between the mode switch and U1 pin 37. • Faulty ribbon cable between main circuit board and front panel. |

| Symptom | Possible Solutions | | | | | | | | | | |
|--|---|------------|------------------------|--|---|--|--|--|---|--|--|
| <p>When auto mode is selected, the front panel antenna buttons all flash quickly at the same time.</p> | <p><u>Non-Icom Transceivers:</u></p> <table border="1" data-bbox="483 317 1446 531"> <thead> <tr> <th data-bbox="483 317 1003 363">Check for:</th> <th data-bbox="1003 317 1446 363">If measurement is bad:</th> </tr> </thead> <tbody> <tr> <td data-bbox="483 363 1003 531"> <ul style="list-style-type: none"> Check for 0 vdc on at least one of the following pins on the microcontroller: pin33, pin34, pin35, or pin36. </td> <td data-bbox="1003 363 1446 531"> <ul style="list-style-type: none"> Radio is not turned on Band data interface cable is faulty on one or more of these pins: 2, 3, 4, or 5 </td> </tr> </tbody> </table> <p><u>Icom Transceivers:</u></p> <table border="1" data-bbox="483 594 1446 772"> <thead> <tr> <th data-bbox="483 594 1003 640">Check for:</th> <th data-bbox="1003 594 1446 640">If measurement is bad:</th> </tr> </thead> <tbody> <tr> <td data-bbox="483 640 1003 772"> <ul style="list-style-type: none"> Check for a voltage between 1.0 vdc and 8 vdc on the R70 lead furthest from TP1. </td> <td data-bbox="1003 640 1446 772"> <ul style="list-style-type: none"> Radio is not on Band data interface cable is faulty on pin 6 </td> </tr> </tbody> </table> | Check for: | If measurement is bad: | <ul style="list-style-type: none"> Check for 0 vdc on at least one of the following pins on the microcontroller: pin33, pin34, pin35, or pin36. | <ul style="list-style-type: none"> Radio is not turned on Band data interface cable is faulty on one or more of these pins: 2, 3, 4, or 5 | Check for: | If measurement is bad: | <ul style="list-style-type: none"> Check for a voltage between 1.0 vdc and 8 vdc on the R70 lead furthest from TP1. | <ul style="list-style-type: none"> Radio is not on Band data interface cable is faulty on pin 6 | | |
| Check for: | If measurement is bad: | | | | | | | | | | |
| <ul style="list-style-type: none"> Check for 0 vdc on at least one of the following pins on the microcontroller: pin33, pin34, pin35, or pin36. | <ul style="list-style-type: none"> Radio is not turned on Band data interface cable is faulty on one or more of these pins: 2, 3, 4, or 5 | | | | | | | | | | |
| Check for: | If measurement is bad: | | | | | | | | | | |
| <ul style="list-style-type: none"> Check for a voltage between 1.0 vdc and 8 vdc on the R70 lead furthest from TP1. | <ul style="list-style-type: none"> Radio is not on Band data interface cable is faulty on pin 6 | | | | | | | | | | |
| <p>A band for which I haven't assigned an antenna already has one assigned.</p> | <p><u>Non-Icom Transceivers:</u></p> <table border="1" data-bbox="483 898 1446 1654"> <thead> <tr> <th data-bbox="483 898 1003 945">Check for:</th> <th data-bbox="1003 898 1446 945">If measurement is bad:</th> </tr> </thead> <tbody> <tr> <td data-bbox="483 945 1003 1123"> <ul style="list-style-type: none"> Place a jumper between the R32 lead furthest from the rear of the controller and the R16 lead closest to the rear of the controller. Confirm 0 vdc on pin 33 of the microcontroller. </td> <td data-bbox="1003 945 1446 1123"> <ul style="list-style-type: none"> Poor solder joint in the BCD_A circuit path Faulty Q4 </td> </tr> <tr> <td data-bbox="483 1123 1003 1302"> <ul style="list-style-type: none"> Place a jumper between the R32 lead furthest from the rear of the controller and the R20 lead closest to the rear of the controller. Confirm 0 vdc on pin 34 of the microcontroller. </td> <td data-bbox="1003 1123 1446 1302"> <ul style="list-style-type: none"> Poor solder joint in the BCD_B circuit path Faulty Q5 </td> </tr> <tr> <td data-bbox="483 1302 1003 1480"> <ul style="list-style-type: none"> Place a jumper between the R32 lead furthest from the rear of the controller and the R24 lead closest to the rear of the controller. Confirm 0 vdc on pin 35 of the microcontroller. </td> <td data-bbox="1003 1302 1446 1480"> <ul style="list-style-type: none"> Poor solder joint in the BCD_C circuit path Faulty Q6 </td> </tr> <tr> <td data-bbox="483 1480 1003 1654"> <ul style="list-style-type: none"> Place a jumper between the R32 lead furthest from the rear of the controller and the R28 lead closest to the rear of the controller. Confirm 0 vdc on pin 36 of the microcontroller. </td> <td data-bbox="1003 1480 1446 1654"> <ul style="list-style-type: none"> Poor solder joint in the BCD_D circuit path Faulty Q7 </td> </tr> </tbody> </table> | Check for: | If measurement is bad: | <ul style="list-style-type: none"> Place a jumper between the R32 lead furthest from the rear of the controller and the R16 lead closest to the rear of the controller. Confirm 0 vdc on pin 33 of the microcontroller. | <ul style="list-style-type: none"> Poor solder joint in the BCD_A circuit path Faulty Q4 | <ul style="list-style-type: none"> Place a jumper between the R32 lead furthest from the rear of the controller and the R20 lead closest to the rear of the controller. Confirm 0 vdc on pin 34 of the microcontroller. | <ul style="list-style-type: none"> Poor solder joint in the BCD_B circuit path Faulty Q5 | <ul style="list-style-type: none"> Place a jumper between the R32 lead furthest from the rear of the controller and the R24 lead closest to the rear of the controller. Confirm 0 vdc on pin 35 of the microcontroller. | <ul style="list-style-type: none"> Poor solder joint in the BCD_C circuit path Faulty Q6 | <ul style="list-style-type: none"> Place a jumper between the R32 lead furthest from the rear of the controller and the R28 lead closest to the rear of the controller. Confirm 0 vdc on pin 36 of the microcontroller. | <ul style="list-style-type: none"> Poor solder joint in the BCD_D circuit path Faulty Q7 |
| Check for: | If measurement is bad: | | | | | | | | | | |
| <ul style="list-style-type: none"> Place a jumper between the R32 lead furthest from the rear of the controller and the R16 lead closest to the rear of the controller. Confirm 0 vdc on pin 33 of the microcontroller. | <ul style="list-style-type: none"> Poor solder joint in the BCD_A circuit path Faulty Q4 | | | | | | | | | | |
| <ul style="list-style-type: none"> Place a jumper between the R32 lead furthest from the rear of the controller and the R20 lead closest to the rear of the controller. Confirm 0 vdc on pin 34 of the microcontroller. | <ul style="list-style-type: none"> Poor solder joint in the BCD_B circuit path Faulty Q5 | | | | | | | | | | |
| <ul style="list-style-type: none"> Place a jumper between the R32 lead furthest from the rear of the controller and the R24 lead closest to the rear of the controller. Confirm 0 vdc on pin 35 of the microcontroller. | <ul style="list-style-type: none"> Poor solder joint in the BCD_C circuit path Faulty Q6 | | | | | | | | | | |
| <ul style="list-style-type: none"> Place a jumper between the R32 lead furthest from the rear of the controller and the R28 lead closest to the rear of the controller. Confirm 0 vdc on pin 36 of the microcontroller. | <ul style="list-style-type: none"> Poor solder joint in the BCD_D circuit path Faulty Q7 | | | | | | | | | | |

| Symptom | Possible Solutions | | | | | | |
|---|--|------------|------------------------|---|--|--|---|
| | <p>Icom Transceivers:</p> <table border="1" style="width: 100%; border-collapse: collapse;"> <thead> <tr> <th style="width: 60%;">Check for:</th> <th style="width: 40%;">If measurement is bad:</th> </tr> </thead> <tbody> <tr> <td data-bbox="500 386 1003 768"> <ul style="list-style-type: none"> • Step through the transceiver's bands one at a time and confirm the following voltages at TP1: <ul style="list-style-type: none"> ○ 160 m: >= 3.26 vdc ○ 80 m: >= 2.76 vdc; <= 3.25 vdc ○ 40 m: >= 2.26 vdc; <= 2.75 vdc ○ 30 m: >= 0.5 vdc; < 0.6 vdc ○ 20 m: >= 1.76 vdc; <= 2.25 vdc ○ 17/15 m: >= 1.26 vdc <= 1.75 vdc ○ 12/10 m: >= 1.0 vdc; <= 1.25 vdc ○ 6 m: >= 0.6 vdc; < 1.0 vdc </td> <td data-bbox="1013 386 1442 768"> <ul style="list-style-type: none"> • Mis-adjusted R71 </td> </tr> </tbody> </table> | Check for: | If measurement is bad: | <ul style="list-style-type: none"> • Step through the transceiver's bands one at a time and confirm the following voltages at TP1: <ul style="list-style-type: none"> ○ 160 m: >= 3.26 vdc ○ 80 m: >= 2.76 vdc; <= 3.25 vdc ○ 40 m: >= 2.26 vdc; <= 2.75 vdc ○ 30 m: >= 0.5 vdc; < 0.6 vdc ○ 20 m: >= 1.76 vdc; <= 2.25 vdc ○ 17/15 m: >= 1.26 vdc <= 1.75 vdc ○ 12/10 m: >= 1.0 vdc; <= 1.25 vdc ○ 6 m: >= 0.6 vdc; < 1.0 vdc | <ul style="list-style-type: none"> • Mis-adjusted R71 | | |
| Check for: | If measurement is bad: | | | | | | |
| <ul style="list-style-type: none"> • Step through the transceiver's bands one at a time and confirm the following voltages at TP1: <ul style="list-style-type: none"> ○ 160 m: >= 3.26 vdc ○ 80 m: >= 2.76 vdc; <= 3.25 vdc ○ 40 m: >= 2.26 vdc; <= 2.75 vdc ○ 30 m: >= 0.5 vdc; < 0.6 vdc ○ 20 m: >= 1.76 vdc; <= 2.25 vdc ○ 17/15 m: >= 1.26 vdc <= 1.75 vdc ○ 12/10 m: >= 1.0 vdc; <= 1.25 vdc ○ 6 m: >= 0.6 vdc; < 1.0 vdc | <ul style="list-style-type: none"> • Mis-adjusted R71 | | | | | | |
| <p>The XMIT LED illuminates when the radio is NOT transmitting.</p> | <table border="1" style="width: 100%; border-collapse: collapse;"> <thead> <tr> <th style="width: 60%;">Check for:</th> <th style="width: 40%;">If measurement is bad:</th> </tr> </thead> <tbody> <tr> <td data-bbox="500 884 1003 957"> <ul style="list-style-type: none"> • ~5 vdc on pin 9 of the microcontroller </td> <td data-bbox="1013 884 1442 957"> <ul style="list-style-type: none"> • Poor solder joint on either R32 or R33 </td> </tr> </tbody> </table> | Check for: | If measurement is bad: | <ul style="list-style-type: none"> • ~5 vdc on pin 9 of the microcontroller | <ul style="list-style-type: none"> • Poor solder joint on either R32 or R33 | | |
| Check for: | If measurement is bad: | | | | | | |
| <ul style="list-style-type: none"> • ~5 vdc on pin 9 of the microcontroller | <ul style="list-style-type: none"> • Poor solder joint on either R32 or R33 | | | | | | |
| <p>The XMIT LED doesn't illuminate when the radio is transmitting.</p> | <table border="1" style="width: 100%; border-collapse: collapse;"> <thead> <tr> <th style="width: 60%;">Check for:</th> <th style="width: 40%;">If measurement is bad:</th> </tr> </thead> <tbody> <tr> <td data-bbox="500 1052 1003 1157"> <ul style="list-style-type: none"> • Check for ~4.7 vdc on the cathode (banded end) of diode D5 while NOT transmitting. </td> <td data-bbox="1013 1052 1442 1157"> <ul style="list-style-type: none"> • Faulty D5 </td> </tr> <tr> <td data-bbox="500 1167 1003 1241"> <ul style="list-style-type: none"> • Check for 0 vdc on the cathode of diode D5 while transmitting. </td> <td data-bbox="1013 1167 1442 1241"> <ul style="list-style-type: none"> • Faulty band data interface cable pin 7. </td> </tr> </tbody> </table> | Check for: | If measurement is bad: | <ul style="list-style-type: none"> • Check for ~4.7 vdc on the cathode (banded end) of diode D5 while NOT transmitting. | <ul style="list-style-type: none"> • Faulty D5 | <ul style="list-style-type: none"> • Check for 0 vdc on the cathode of diode D5 while transmitting. | <ul style="list-style-type: none"> • Faulty band data interface cable pin 7. |
| Check for: | If measurement is bad: | | | | | | |
| <ul style="list-style-type: none"> • Check for ~4.7 vdc on the cathode (banded end) of diode D5 while NOT transmitting. | <ul style="list-style-type: none"> • Faulty D5 | | | | | | |
| <ul style="list-style-type: none"> • Check for 0 vdc on the cathode of diode D5 while transmitting. | <ul style="list-style-type: none"> • Faulty band data interface cable pin 7. | | | | | | |

SCHEMATIC DIAGRAMS

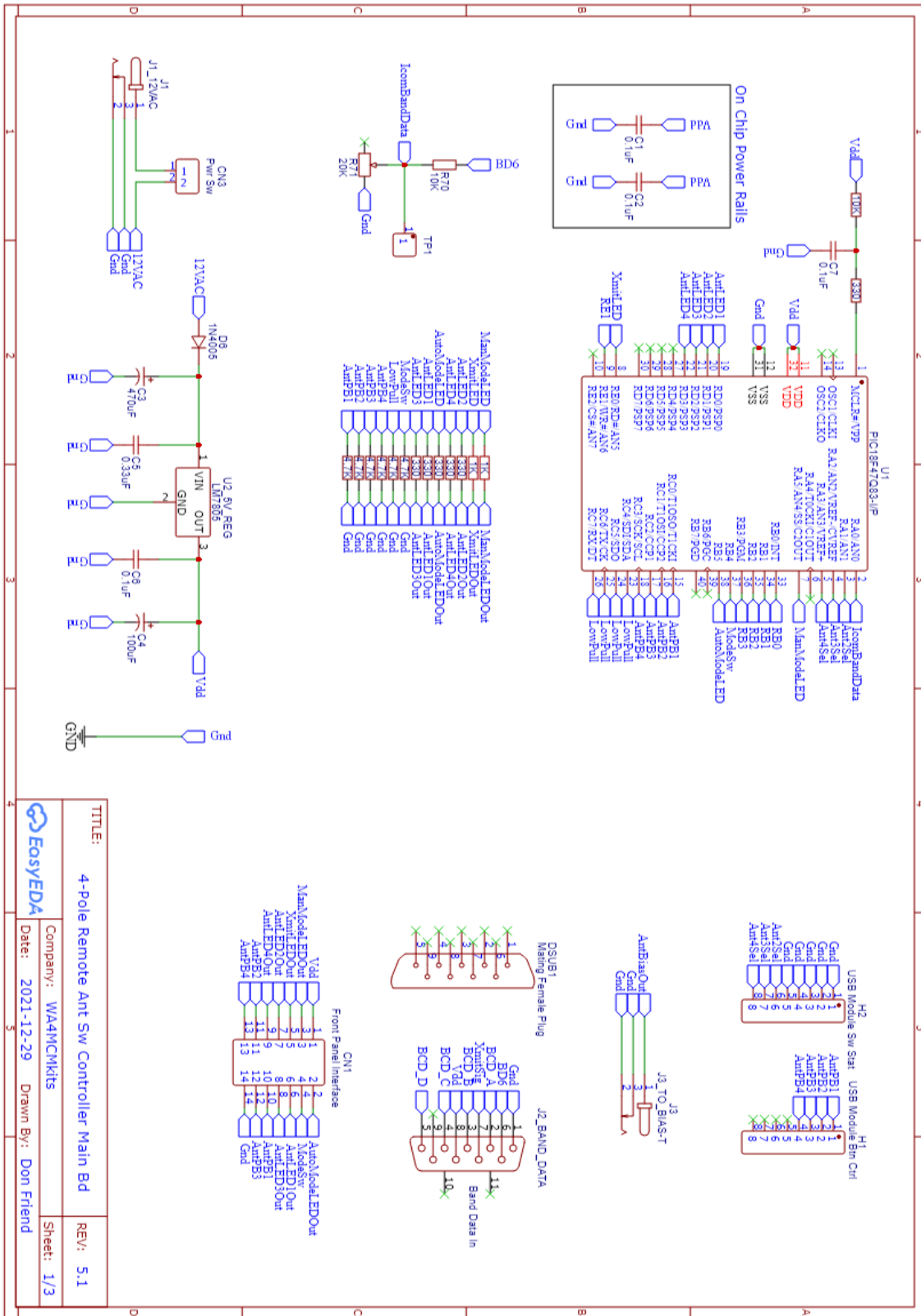

TITLE: 4-Pole Remote Ant Sw Controller Main Bd
 Company: WA4MCMkits
 Date: 2021-12-29
 Drawn By: Don Friend
 REV: 5.1
 Sheet: 1/3

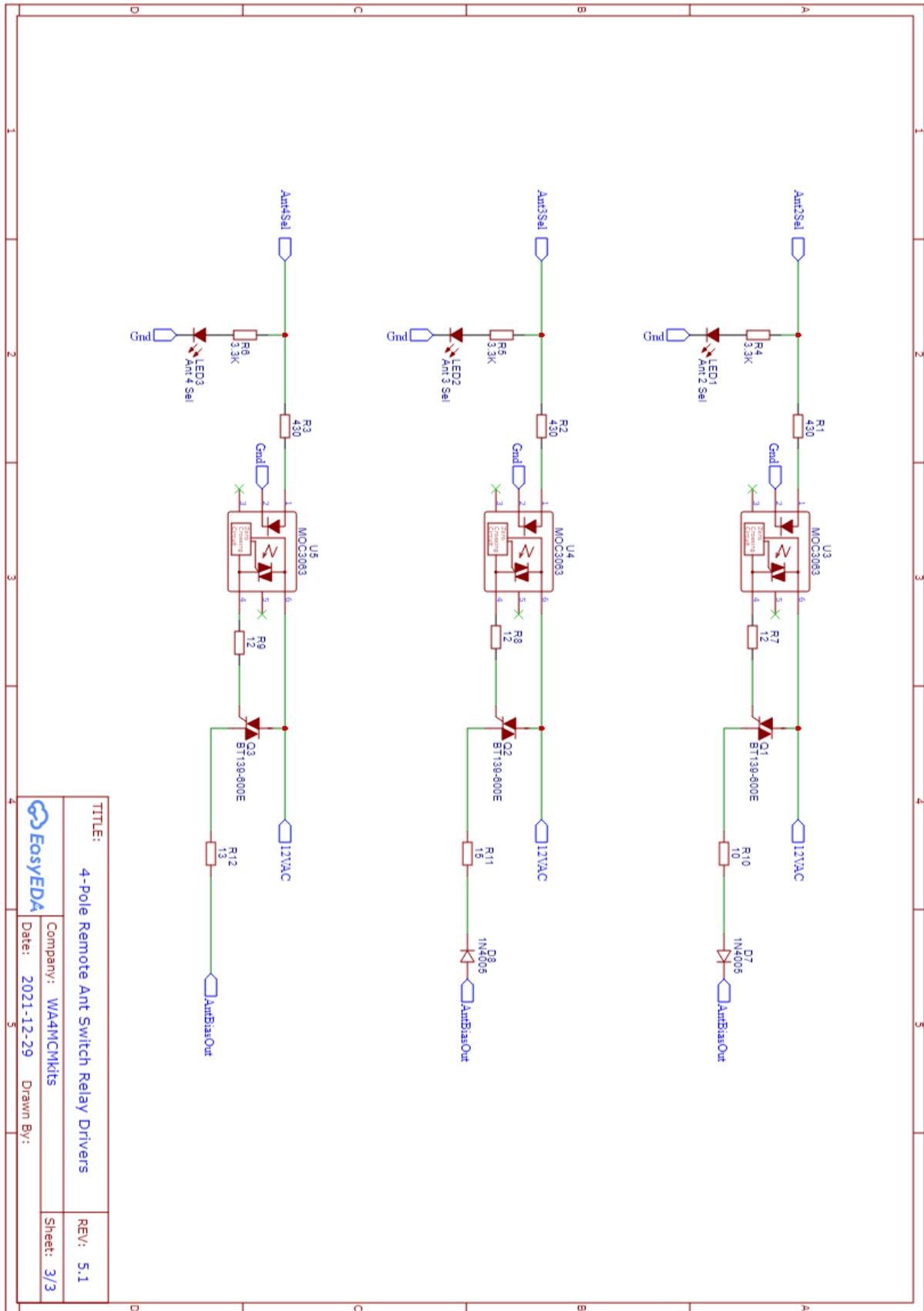

| | | |
|---|-----------|------------|
| TITLE: 4-pole Remote Ant Switch Relay Drivers | | REV: 5.1 |
| Company: WA4MCMkits | | Sheet: 3/3 |
| Date: 2021-12-29 | Drawn By: | |

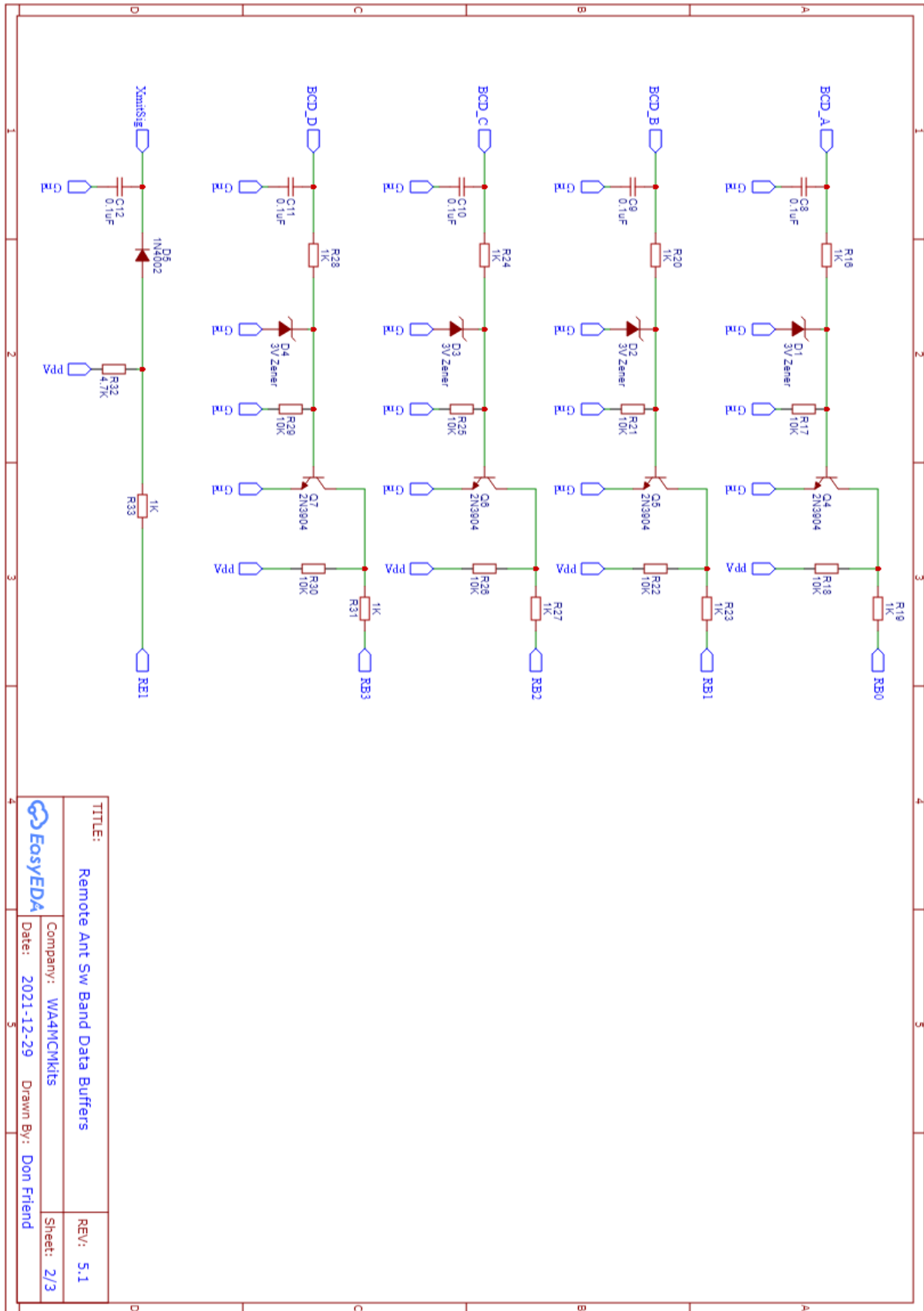

| | | | |
|----------|------------|---------------------------------|------------|
| TITLE: | | Remote Ant Sw Band Data Buffers | REV: 5.1 |
| Company: | | WA4MCMkits | Sheet: 2/3 |
| Date: | 2021-12-29 | Drawn By: | Don Friend |

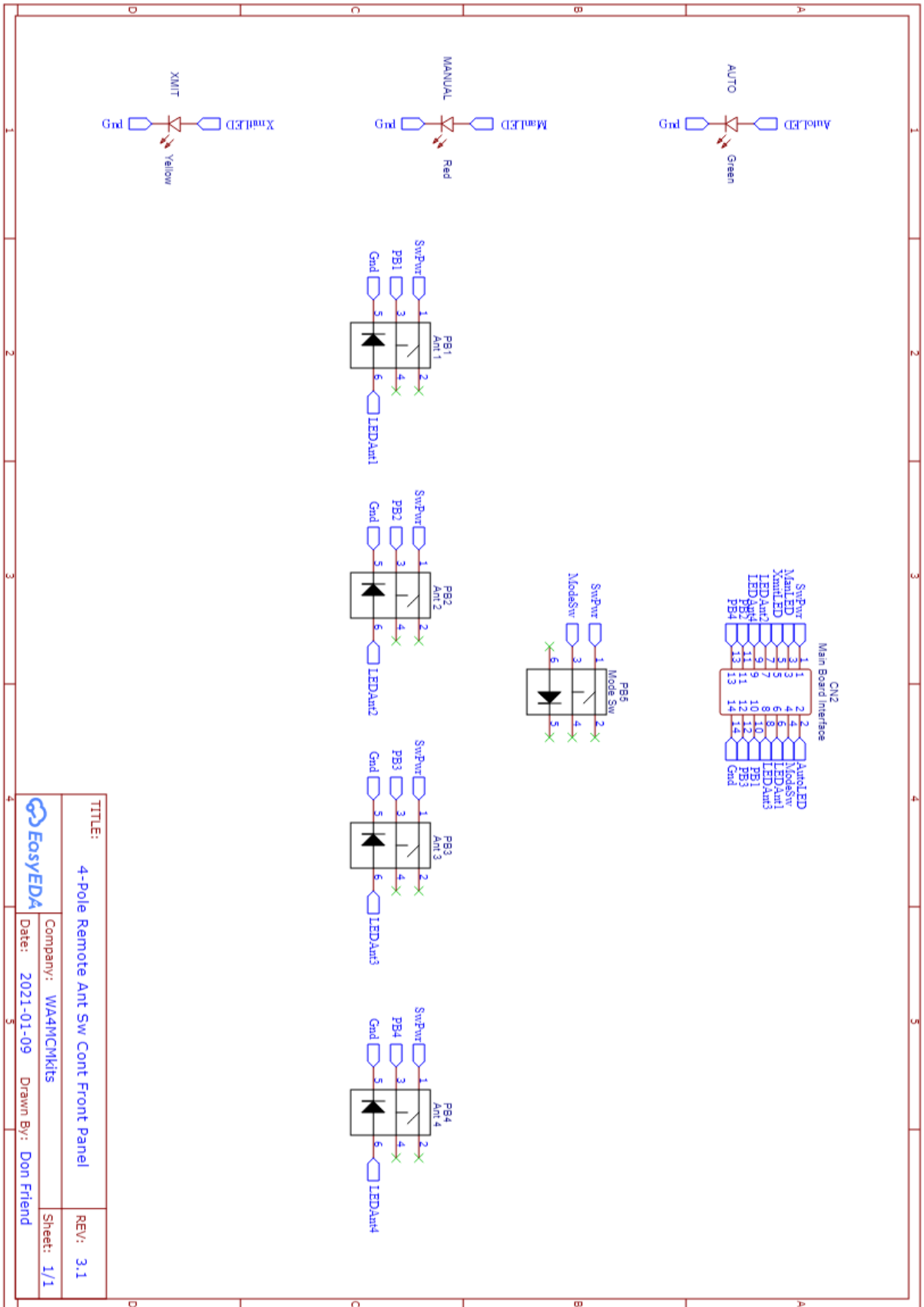

| | | | |
|-----------|--|---------------------------------------|--|
| TITLE: | | 4-pole Remote Ant Sw Cont Front Panel | |
| Company: | | WA4MCMkits | |
| Date: | | 2021-01-09 | |
| Drawn By: | | Don Friend | |
| REV: | | 3.1 | |
| Sheet: | | 1/1 | |

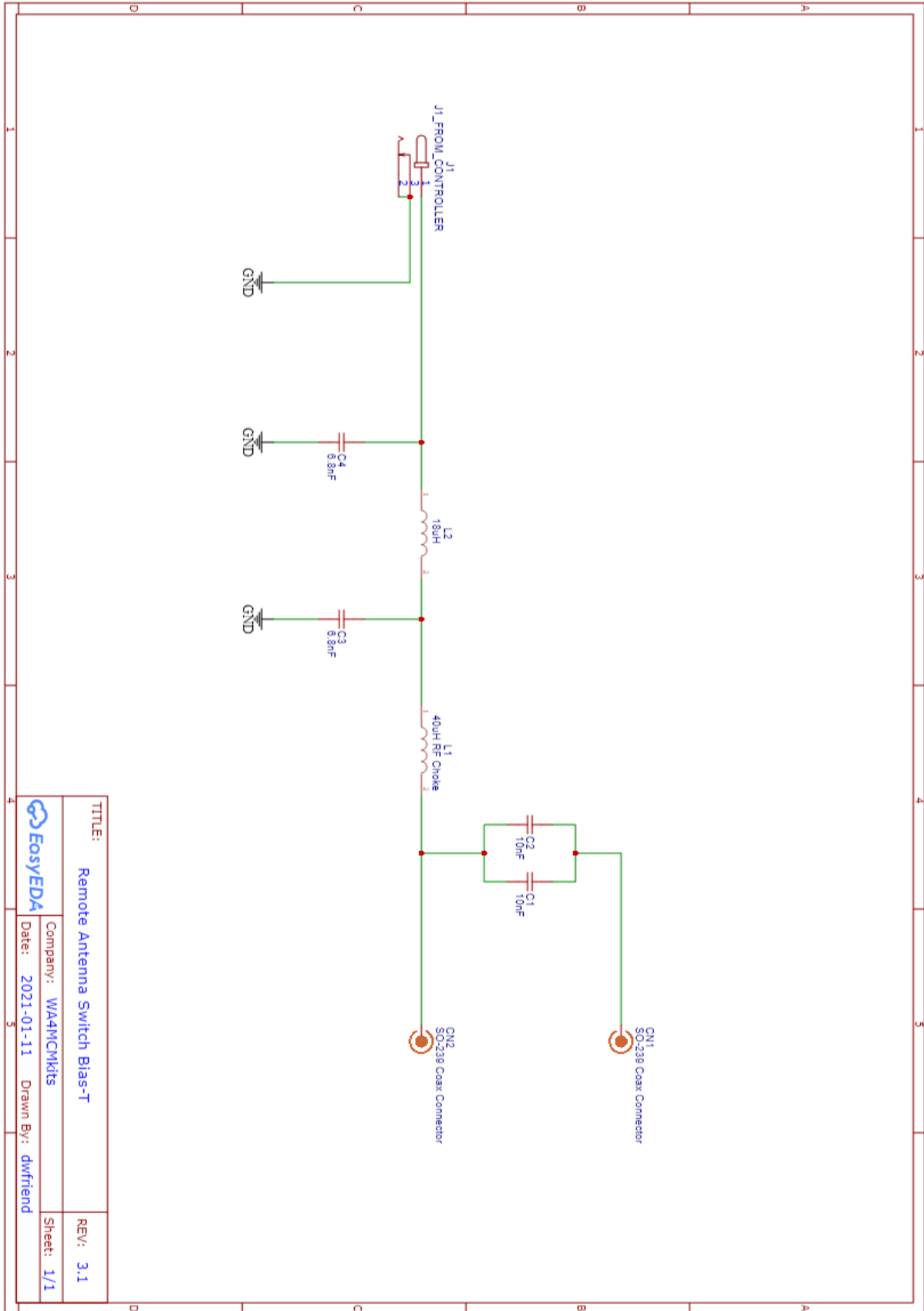

| | | |
|-------------------------------------|--------------------|------------|
| TITLE: Remote Antenna Switch Bias-T | | REV: 3.1 |
| Company: WA4MCMkits | | Sheet: 1/1 |
| Date: 2021-01-11 | Drawn By: dwfriend | |

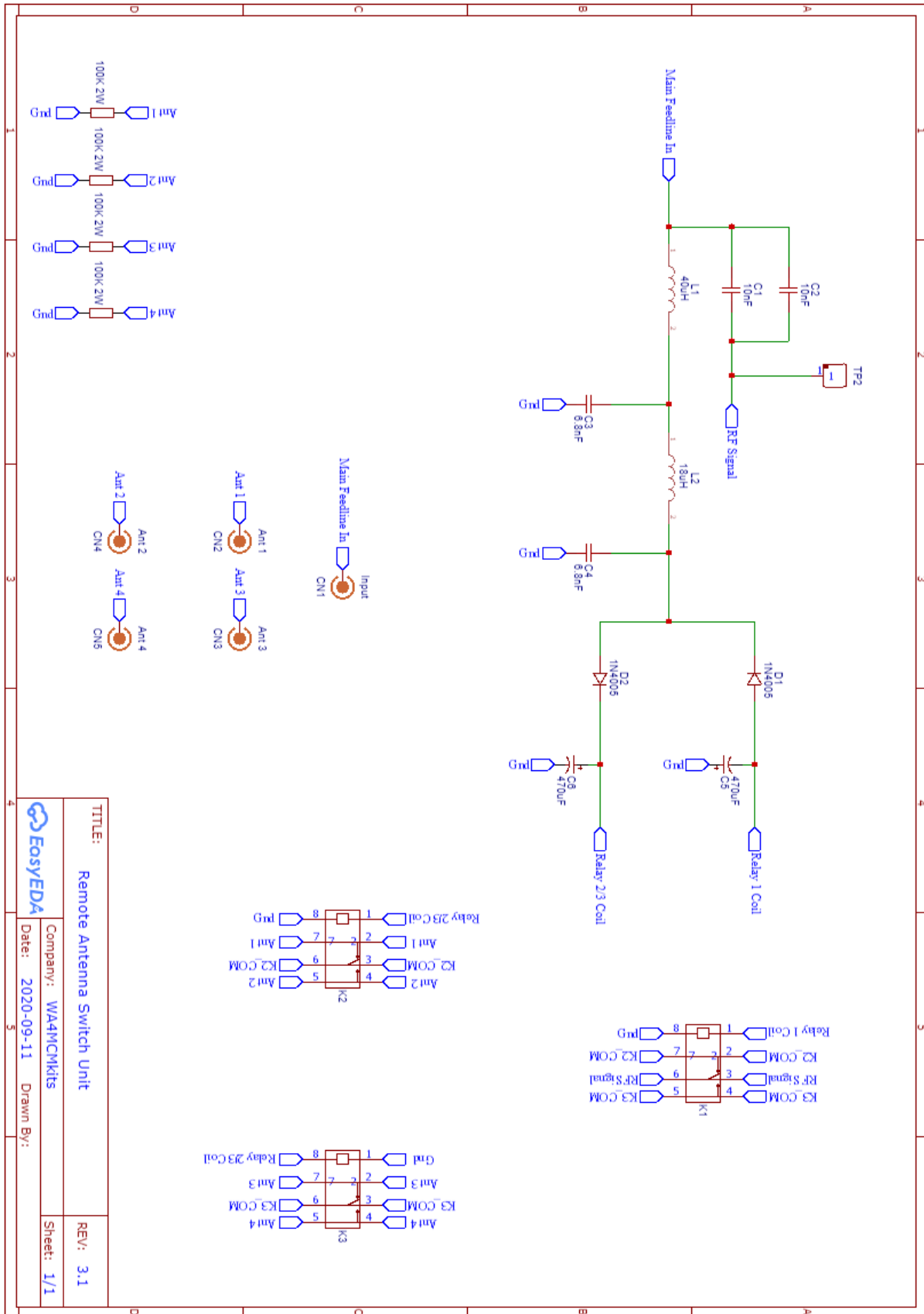

TITLE: Remote Antenna Switch Unit
 Company: WA4MCMkits
 Date: 2020-09-11 Drawn By:
 REV: 3.1
 Sheet: 1/1

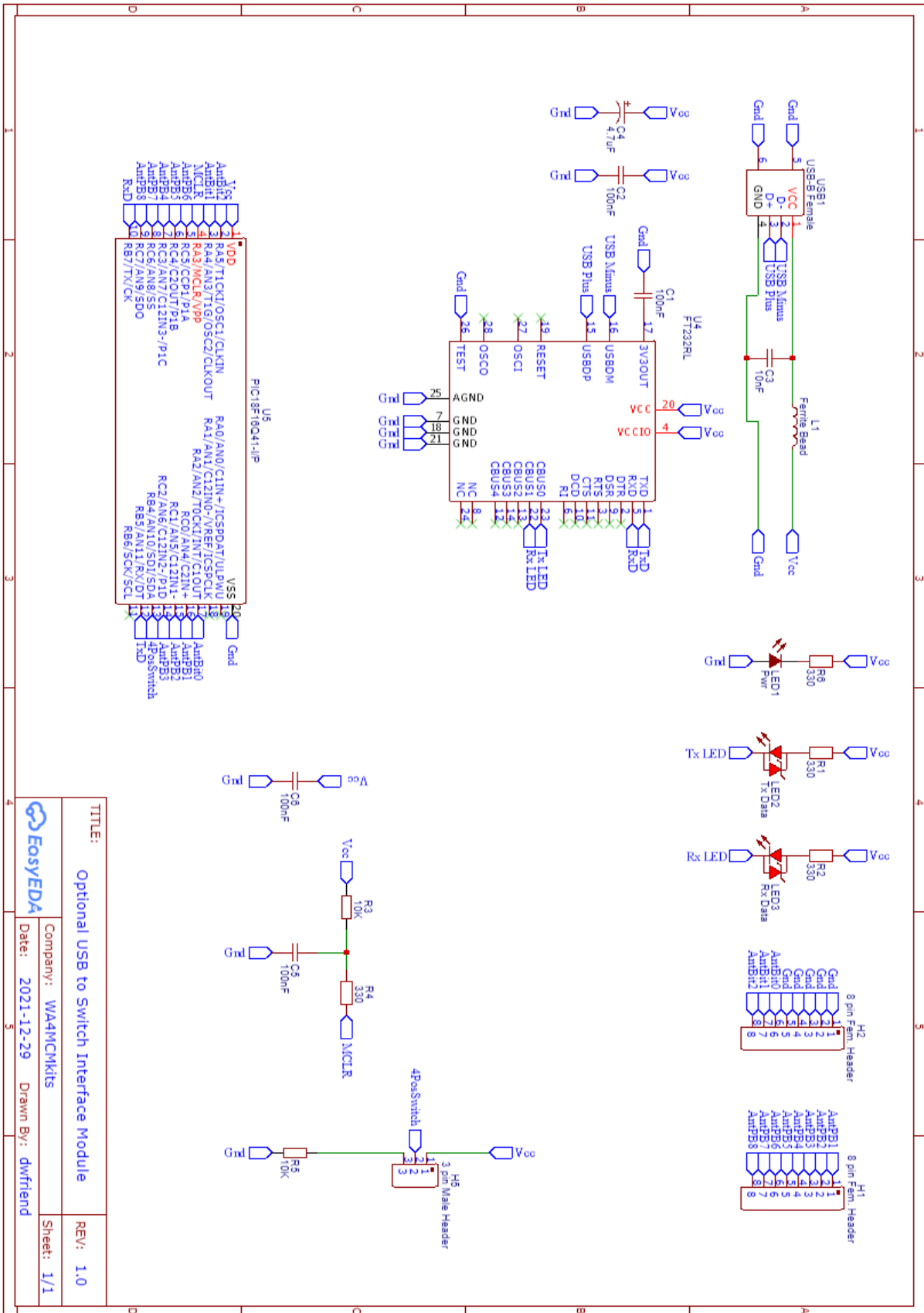

TITLE: Optional USB to Switch Interface Module

Company: WA4MCMkits

Date: 2021-12-29

Drawn By: dwfriend

REV: 1.0

Sheet: 1/1