

ASSEMBLY MANUAL GM-102 SWR & Wattmeter Kit

Revision History

Revision Number	Date	Description	Notes
1.1	3/17/2023	<ul style="list-style-type: none"> Added a step for actually installing the OpAmp into its socket – duh. Added capacitor markings to their respective installation steps similar to how the resistor color codes are included with each of their installation steps. 	<ul style="list-style-type: none"> Thanks to George – W3GP for his suggestion.
1.2	4/7/2023	<ul style="list-style-type: none"> Added the trimmer potentiometers to the list of components that will be installed on the backside of the main circuit board. Added the trimmer potentiometer value markings to their respective installation steps to make identification easier. Added the main cabinet’s rubber feet and cover hardware to the parts list. Changed wording on step 20 to reflect the fact that there are two IDC headers -vs- one. Added wording in the parts list to reflect the possibility of a slight variation in the DC Power Jack caused by supply chain issues. Also needed to reflect this in the main board version number. Step 88 – changed “Click on” to “Touch” the Save button – because, after all, it’s a touch screen. 	<ul style="list-style-type: none"> Thanks to Mark – K4SO for his review and suggestions.
1.3	6/27/2023	<ul style="list-style-type: none"> Fixed duplicate step numbers for step 91. 	
1.4	7/2/2023	<ul style="list-style-type: none"> Added a link at the beginning of the Calibration and Testing section to a new calibration procedure YouTube video. 	Thanks to Jacob - N8JCM for the video idea.
1.5	7/24/2023	<ul style="list-style-type: none"> Added a direction to trim the excess leads from the trimmer resistors after soldering them to the main circuit board. Modified the parts list as well as the 5 volt regulator steps to reflect the replacement of the 78L05 with an LM7805 plus heat sink. 	Thanks to Fred - K4PZZ for pointing out the discrepancy. Original 5V regulator running too hot.
1.6	8/28/2023	<ul style="list-style-type: none"> Fixed resistor color code for 1.8MΩ resistor in step #7. 	
1.7	9/11/2023	<ul style="list-style-type: none"> Refined the installation steps for the +5V linear voltage regulator and heat sink to make the final orientation clearer. Changed the recommended solder chemistry to 63% Tin / 37% Lead for easier soldering. 	

1.8	11/15/2023	<ul style="list-style-type: none"> Added a step for using the 500 grit Silicon Carbide Sandpaper to dull the sharp edge of the brass tubing. Changed the parts description of the 470Ω resistor so that it shows it as a ¼ watt rather than a ½ watt resistor. Modified the step that addresses inserting the TFT module into the bezel since the kits are now shipped with the module already inserted. Fixed the note prior to step 23. Corrected the recommended soldering iron temperature in the soldering tips section – changed °F to °C. 	<p>Thanks to Carl – W5SU for pointing out the discrepancy on the resistor as well as the heads-up on the sharp end of the brass tubing which may nick the enameled wire.</p> <p>Thanks to Kirk – KD9REK for his sharp eyes on the soldering iron temp.!</p>
1.9	12/28/2023	<ul style="list-style-type: none"> Modified multiple steps in the calibration and peak hold test sections to accommodate changes made in the new firmware release (v1.2.1) 	
1.10	3/2/2024	<ul style="list-style-type: none"> Corrected a typo in the parts list for the sensor module. Changed the 1N7511 to the correct part: 1N5711. Added a tip for how to adequately keep the SO-239 connectors on the sensor box from spinning while tightening them. 	<p>Thanks to Greg – AB7R for his sharp eyes!</p>
1.11	4/8/2024	<ul style="list-style-type: none"> Added notes to the parts list that the body color and size of all resistors may vary. Added picture of the new sensor enclosure in the parts list. 	
1.12	8/26/2024	<ul style="list-style-type: none"> Fixed the rough power calculation formulas in the Power Scale Calibration section to use Vdc - vs- Vrms. 	

CONTENTS

Getting Started	1
Required Tools and supplies	1
Recommended Tools	1
Parts Inventory	2
Tips for Successful Soldering	10
Circuit Board Assembly	12
SWR & Wattmeter Main Board	12
TFT Display Board Interface	19
SWR / Power Sensor Board	20
Final Assembly	29
Meter Enclosure	29
Install the MCU, OpAmp and ADC Modules	29
TFT Display Module	31
SWR & Wattmeter Main Board	34
Power Switch and Ribbon Cable	35
Power Sensor Box	36
Calibration and Testing	44
SWR Balance Adjustment	44
Power Scale Calibration	45
Peak Hold Test	48
Troubleshooting	49
Schematic Diagrams	58

GETTING STARTED

These instructions are specifically structured to guide you through the steps required to easily complete the assembly of the SWR & Wattmeter. The order of the sections and steps has been chosen to reduce any instances where awkward soldering or physical assembly would be needed. For instance, resistors are installed early in the main board assembly since they sit very close to the circuit board and have less chance of interfering with component placement while installing any later components such as the transistors and voltage regulators.

There are no “hard” soldering tasks on this kit. Anyone with beginner-level or better soldering skills should be able to successfully complete that portion of the assembly.

REQUIRED TOOLS AND SUPPLIES

The following tools and supplies are required to complete the assembly of the remote antenna switch:

- Soldering Iron – At least 60 watts with a thin tip is recommended. A temperature-controlled soldering station would be preferred.
- Rosin core solder – please see the soldering tips section below for a discussion on choosing between leaded or non-leaded solder compositions.
- #1 and #2 phillips-head screw drivers
- Small, non-conductive straight-slot screwdriver or alignment tool for adjusting variable resistors and capacitors. A good example would be a GC8271 6” TV Core Aligner Tool
- Small needle-nosed pliers
- Small diagonal wire cutters
- Nut drivers (or sockets/wrenches) in the following sizes: 3/16”, 1/4”, 5/16”, 3/8”
- Wire strippers
- High input impedance multi-meter w/ test leads (not shown)
- 50Ω non-reactive dummy load (not shown)



Figure 1 - Required Hand Tools



Figure 2 - GC8271 6" Core Alignment Tool

RECOMMENDED TOOLS

The following tools are recommended to make the assembly process easier and more precise, but are not required:

- “Helping Hands” station equipped with a magnifying glass.
- Calibrated RF Probe or Oscilloscope capable of measuring your transmitter’s RF output RMS volts.









- Calibrated wattmeter to use as a comparison during the *Power Scale Calibration* section.



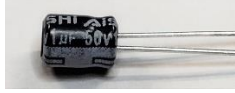







PARTS INVENTORY



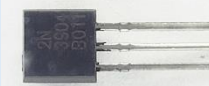



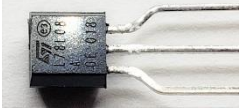

After unpacking all kit components and hardware, please refer to the following tables to ensure everything has been included and identified before moving to the actual assembly sections of this manual. If anything is missing, please contact the seller for replacements.

Table 1 – Meter & Main Board Parts

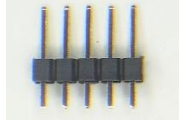
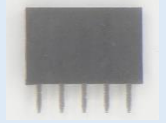
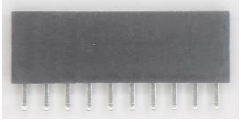
<input checked="" type="checkbox"/>	Component	Qty	Circuit Designator(s)	Identifying Marks	Image
<input type="checkbox"/>	Meter Enclosure	1	N/A	N/A	
<input type="checkbox"/>	Circuit Board – Meter Main Board	1	N/A	Version 1.8 -or- Version 1.9 (Depends on the 5V Linear Regulator Type)	
<input type="checkbox"/>	Circuit Board - TFT Display Interface	1	N/A	TFT Display End Display Interface SWR-Power Meter	
<input type="checkbox"/>	DC Power Jack	1	J1	Actual configuration may vary slightly	
<input type="checkbox"/>	12V 1A DC Power Supply Wall AC Adapter	1	N/A	N/A	
<input type="checkbox"/>	5' Braided Stereo Cable	1	N/A	Cable color may vary	
<input type="checkbox"/>	3.5mm Stereo Jack	1	J2	N/A	



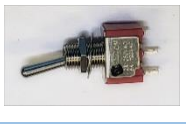
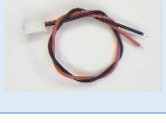



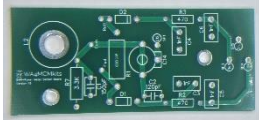

<input checked="" type="checkbox"/>	Component	Qty	Circuit Designator(s)	Identifying Marks	Image
<input type="checkbox"/>	USB-B Socket	1	USB1	N/A	
<input type="checkbox"/>	33 nf Ceramic Disk Capacitor	2	C6, C7	333	
<input type="checkbox"/>	100 nf Ceramic Disk Capacitor	4	C4, C5, C8, C9	104	
<input type="checkbox"/>	.33 µf Ceramic Disk Capacitor	1	C3	334 CSK (But may vary)	
<input type="checkbox"/>	1 µf Electrolytic Capacitor	2	C1, C2	1 µf 50V	
<input type="checkbox"/>	10Ω ¼ Watt Resistor	2	R3, R4	Brown / black / black / gold / brown (Body color and size may vary)	
<input type="checkbox"/>	1kΩ ¼ Watt Resistor	6	R17, R18, R19, R20, R21, R22	brown / black / red / gold (Body color and size may vary)	
<input type="checkbox"/>	12KΩ ¼ Watt Resistor	2	R9, R10	Brown / red / black / red / brown (Body color and size may vary)	
<input type="checkbox"/>	20kΩ ¼ Watt Resistor	2	R7, R8	Red / black / black / red / brown (Body color and size may vary)	
<input type="checkbox"/>	180kΩ ¼ Watt Resistor	2	R5, R6	Brown / grey / yellow / gold (Body color and size may vary)	
<input type="checkbox"/>	1.8MΩ ¼ Watt Resistor	2	R1, R2	Brown / grey / black / yellow / brown (Body color and size may vary)	
<input type="checkbox"/>	1kΩ Trimmer Resistor	2	R13, R16	X 102	

<input checked="" type="checkbox"/>	Component	Qty	Circuit Designator(s)	Identifying Marks	Image
<input type="checkbox"/>	5kΩ Trimmer Resistor	2	R12, R15	X 502	
<input type="checkbox"/>	20kΩ Trimmer Resistor	2	R11, R14	X 203	
<input type="checkbox"/>	1N5711 Schottky Diode	2	D1, D2	1N5711	
<input type="checkbox"/>	5.1V Zener Diode	2	D3, D4	1N4733A 5.1	
<input type="checkbox"/>	ESP32-S3 MCU Module	1	N/A	Version 5.0	
<input type="checkbox"/>	2N7000 N-Channel MOSFET	8	Q1, Q2, Q3, Q4, Q5, Q6, Q7, Q8	2N7000 CUC	
<input type="checkbox"/>	LM324 Quad OpAmp	1	U3	LM324A	
<input type="checkbox"/>	14-Pin DIP IC Socket	1	U3	N/A	
<input type="checkbox"/>	Analog-to-digital Converter Module	1	N/A	Version 1.0	
<p>Note: The following 2 components (LM7805 and TO-220 Heat Sink are supplied with newer kits beginning 7/24/2023. They replace the previous 5V Linear Voltage Regulator type (75L05)</p>					
<input type="checkbox"/>	LM7805 5V Linear Voltage Regulator	1	U2	LM7805	
<input type="checkbox"/>	TO-220 Heat Sink	1	U2	N/A	
<p>Note: The following component (75L05) has been replaced with the LM7805 and heat sink on kits sold after 7/23/2023.</p>					





<input checked="" type="checkbox"/>	Component	Qty	Circuit Designator(s)	Identifying Marks	Image
<input type="checkbox"/>	78L05 5V Linear Voltage Regulator	1	U2	78L05 2101L	
<input type="checkbox"/>	78L08 8V Linear Voltage Regulator	1	U1	L78L08A GE 018	
<input type="checkbox"/>	2-pin female header	1	H3	N/A	
<input type="checkbox"/>	5-pin male pin header	2	H4, H5	N/A	
<input type="checkbox"/>	5-pin female header	2	H4, H5	N/A	
<input type="checkbox"/>	10 pin female header	2	H1, H2	N/A	
<input type="checkbox"/>	14 pin female right-angle header	1	N/A	N/A	
<input type="checkbox"/>	14 Pin IDC Header	2	CN2 and Display Interface Board	N/A	
<input type="checkbox"/>	2" x 14 conductor ribbon cable assembly	1	N/A	N/A	
<input type="checkbox"/>	Toggle Switch	1	N/A	The switch's color may vary	
<input type="checkbox"/>	6" x 2 conductor twisted pair cable assembly	1	N/A	N/A	
<input type="checkbox"/>	2 Conductor JST XH PCB Header	1	CN1	N/A	

<input checked="" type="checkbox"/>	Component	Qty	Circuit Designator(s)	Identifying Marks	Image
<input type="checkbox"/>	3.5" TFT Graphical Display Module	1	N/A	N/A	
<input type="checkbox"/>	Display Bezel	1	N/A	N/A	
<input type="checkbox"/>	Display Assembly locking key	1	N/A	N/A	
<input type="checkbox"/>	4-40 x 1/2 hex standoff	4	N/A	N/A	
<input type="checkbox"/>	4-40 x 1/4 pan head machine screw	4	N/A	N/A	
<input type="checkbox"/>	4-40 hex nut	4	N/A	N/A	
<input type="checkbox"/>	Adhesive Rubber Cabinet Feet	4	N/A	N/A	
<input type="checkbox"/>	M3x0.5x5mm Cabinet Cover Screws	4	N/A	N/A	

Table 2 – SWR / Power Sensor Parts

<input checked="" type="checkbox"/>	Component	Qty	Circuit Designator(s)	Identifying Marks	Image
<input type="checkbox"/>	Power Sensor Enclosure	1	N/A		
<input type="checkbox"/>	Circuit Board – Power Sensor	1	N/A	Rev 1.6	
<input type="checkbox"/>	SO-239 UHF Coax Connector	2	N/A	N/A	
<input type="checkbox"/>	FT50-43 Toroid Core	1	N/A	N/A	
<input type="checkbox"/>	12" Length of 26ga Green Enameled Wire	1	N/A	N/A	
<input type="checkbox"/>	12" Length of 26ga Red Enameled Wire	1	N/A	N/A	
<input type="checkbox"/>	2" Length of #14 THHN Solid Copper Wire	1	N/A	Insulation color may vary	
<input type="checkbox"/>	6" Length of 24ga Insulated Hookup Wire	1	N/A	Insulation color may vary	
<input type="checkbox"/>	500 grit Silicon Carbide Sandpaper	1	N/A	N/A	
<input type="checkbox"/>	7/16" Length of 5mm O.D. Brass Tubing	1	N/A	N/A	

<input checked="" type="checkbox"/>	Component	Qty	Circuit Designator(s)	Identifying Marks	Image
<input type="checkbox"/>	Wooden Tubing Alignment Jig	1	N/A	N/A	
<input type="checkbox"/>	2.5pf – 22pf Trimmer Capacitor	1	C14	N/A	
<input type="checkbox"/>	82pf Ceramic Disk Capacitor	1	C12	82 J	
<input type="checkbox"/>	120pf Ceramic Disk Capacitor	1	C2	B 121 1 K	
<input type="checkbox"/>	150pf Ceramic Disk Capacitor	1	C1	151	
<input type="checkbox"/>	1 nf Ceramic Disk Capacitor	4	C3, C4, C5, C6	B STE 102K 2KV	
<input type="checkbox"/>	1N5711 Diode	2	D1, D2	N/A	
<input type="checkbox"/>	FT-43-101 Ferrite Bead	3	FB1, FB2, FB3	N/A	
<input type="checkbox"/>	3.5mm Panel-mounted Stereo Jack	1	J1	N/A	
<input type="checkbox"/>	68Ω 1W Resistor	1	R1	blue / grey / black / gold (Body color and size may vary)	
<input type="checkbox"/>	470Ω ¼ Watt Resistor	2	R2, R3	yellow / violet / brown / gold (Body color and size may vary)	

<input checked="" type="checkbox"/>	Component	Qty	Circuit Designator(s)	Identifying Marks	Image
<input type="checkbox"/>	3.3kΩ ½ Watt Resistor	1	R7	orange / orange / red / gold (Body color and size may vary)	
<input type="checkbox"/>	4-40 x 7/8 hex standoff	2	N/A	N/A	
<input type="checkbox"/>	4-40 x 1/4 pan head machine screw	2	N/A	N/A	
<input type="checkbox"/>	4-40 hex nut	2	N/A	N/A	

TIPS FOR SUCCESSFUL SOLDERING

This kit has been designed to ensure relatively easy soldering. Also, the components have been placed on the circuit boards with plenty of spacing. Finally, we have chosen to use all through hole rather than surface mount components to accommodate beginning kit builders.

If this is your first attempt at building an electronics kit, or it has been a while since you've wielded a soldering iron, please refer to the following soldering tips:

1. Wear safety glasses! Consider using a small fan to blow the soldering fumes away from your nose.
2. Use a good soldering iron, or a temperature-controlled soldering station. A soldering station is preferred since it would likely come with a tip cleaning station. See *Figure 3 - Soldering Station Example* for a common example of an inexpensive soldering station. Decent soldering stations will cost about \$20 to \$30.
3. Consider using a "helping hands" station. Some versions of these also include a magnifying glass which will come in handy with some of the smaller components. Refer to *Figure 4 - "Helping Hands" Example* for an example.
4. Use the thinnest solder appropriate for the project – a diameter of around .032 works well for the type of circuit board soldering encountered on this kit.
5. 63/37 (Tin/Lead) solder is recommended for beginners since the lead content lowers the melting point of the solder which allows for much easier soldering. However, lead can be harmful to humans, so there are non-lead solders available. These non-lead types of solder have their drawbacks – the most prevalent being the high melting temperature. In the end, it is up to the individual to decide which type of solder to use.
6. Allow the soldering iron to reach its working temperature before trying to solder any components. A good working temperature for the types of components used in this kit is between 325° C and 375° C. This will also depend on the type of solder being used – please refer to the solder manufacturer's recommendations for the optimum temperature.
7. Tin the soldering iron by applying a small amount of solder directly on the iron's tip prior to touching the iron to the circuit board and component being soldered. The reason for this is that a tinned tip will transfer heat much faster, thus reducing the amount of time needed to get the solder to flow around the component lead and circuit board pad.
8. Try to structure your soldering activities by placing several components on the circuit board before picking up the soldering iron. This allows for more efficient soldering since the iron will remain tinned throughout this soldering cycle.



Figure 3 - Soldering Station Example



Figure 4 - "Helping Hands" Example

9. Apply the tip of the soldering iron evenly to both the circuit board pad and the component lead first. Then touch the solder to the lead and allow it to spread, or “flow” as it’s known in the trade. When you see the solder flow, you will know that you have a strong, well soldered joint.
10. Don't use too much solder– “the bigger the blob, the better the job” is not true here. Some have described the perfect solder joint as looking like a small Hershey’s Kiss (or a small volcano if you don’t like chocolate).
11. Clean the tip often using brass wool, or a damp sponge. Brass wool has become the preferred material since it will not lower the temperature of the soldering tip. The constant cooling and reheating of the tip can shorten its life due to contraction and expansion. However, a damp sponge will clean the tip as well.
12. Don't move the joint while it is cooling, and don't blow on it to cool it off. This can cause a “cold” solder joint which can result in a high electrical resistance between the component and the circuit board.

CIRCUIT BOARD ASSEMBLY

Since most of this kit's assembly is performed on the three circuit boards, it's best to start there. The order of assembling the boards doesn't matter, but the order at which components are placed on each individual board does have a bearing on how easy it is to complete the board. The steps listed within each board's section have been arranged to make it as easy as possible to place and solder the component leads.

SWR & WATTMETER MAIN BOARD

Note: With the exception of the 12VDC Power Jack, USB-B Socket, Trimmer Resistors R11-R16, and 3.5mm Stereo Jack, all soldering will be done on the underside of this circuit board.

- 1 Place the 14-pin IC socket for the LM324 Quad-OpAmp on the circuit board.

Important! - Ensure that the small notch on the socket is aligned with the outline printed on the circuit board.

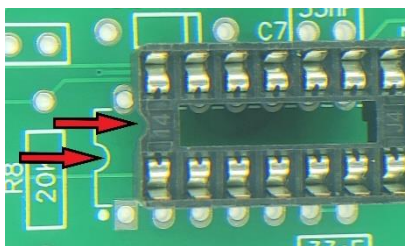

Turn the circuit board over while holding the socket in place, and carefully lay the board down on the work surface. Ensure that all 14 pins are still protruding through the circuit board. Solder one of the pins while ensuring that the socket remains flush with the circuit board. Then solder the remaining 13 pins before moving to the next step.

Note: Most of the components on this board all have wire leads. The following tips will help with the placement and soldering of these components:

- The following illustration shows how to “lock” the component in place by slightly bending the leads.

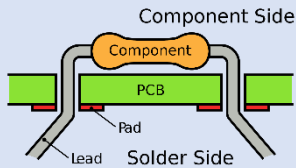

- For the resistors and diodes, use your needle nosed pliers to bend the leads on either side of the component so that they fit the holes provided for that component.
- Trim the leads using your diagonal wire cutters so they only protrude about ½ inch beyond the bottom of the circuit board.
- All components will have their component number printed as close as possible to their outline.
- Where possible, the component’s value will be printed within their outline. If there is no room within the outline, then the value will be printed as close to it as possible.

2 Insert each of the 2 **10 Ω ¼ watt resistors (brown / black / black / gold / brown)** at their respective locations: **R3 and R4**. Then solder all 4 leads. Once all leads have been soldered, cut the excess leads flush with the solder joint using your diagonal cutters.

3 Insert each of the 6 **1 kΩ ¼ watt resistors (brown / black / red / gold)** at their respective locations: **R17, R18, R19, R20, R21, and R22**. Then solder all 12 leads. Once all leads have been soldered, cut the excess leads flush with the solder joint using your diagonal cutters.

4 Insert each of the 2 **12 kΩ ¼ watt resistors (brown / red / black / red / brown)** at their respective locations: **R9 and R10**. Then solder all 4 leads. Once all leads have been soldered, cut the excess leads flush with the solder joint using your diagonal cutters.

5 Insert each of the 2 **20 kΩ ¼ watt resistors (red / black / black / red / brown)** at their respective locations: **R7 and R8**. Then solder all 4 leads. Once all leads have been soldered, cut the excess leads flush with the solder joint using your diagonal cutters.

6 Insert each of the 2 **180 kΩ ¼ watt resistors (brown / grey / yellow / gold)** at their respective locations: **R5 and R6**. Then solder all 4 leads. Once all leads have been soldered, cut the excess leads flush with the solder joint using your diagonal cutters.

7 Insert each of the 2 **1.8 MΩ ¼ watt resistors (brown / grey / black / yellow / brown)** at their respective locations: **R1 and R2**. Then solder all 4 leads. Once all leads have been soldered, cut the excess leads flush with the solder joint using your diagonal cutters.

8 Insert each of the 2 **33 nf ceramic disk capacitors (333)** at their respective locations: **C6 and C7**. Then solder all 4 leads. Once all leads have been soldered, cut the excess leads flush with the solder joint using your diagonal cutters.

9 Insert each of the 4 **100 nf ceramic disk capacitors (104)** at their respective locations: **C4, C5, C8, and C9**. Then solder all 8 leads. Once all leads have been soldered, cut the excess leads flush with the solder joint using your diagonal cutters.

- 10 Insert the **0.33 μ F ceramic disk capacitor (334 CSK)** at its location **C3**. Then solder both leads. Once they have been soldered, cut the excess leads flush with the solder joint using your diagonal cutters.

- 11 Insert each of the 2 **1 μ F electrolytic capacitors** at their respective locations: **C1 and C2**.

Important! - Ensure that you observe the polarity of this capacitor. The white stripe on the side of the capacitor's "can" denotes the NEGATIVE lead. Make sure that this lead is placed in the hole closest to the white mark on the circuit board outline.

Then solder all 4 leads. Once they have been soldered, cut the excess leads flush with the solder joint using your diagonal cutters.

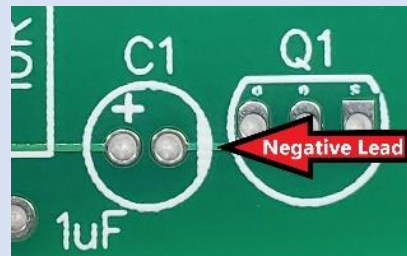

- 12 Insert each of the 2 **5.1V Zener diodes** at their respective locations: **D3, and D4**.

Important! - Ensure that the black stripe on each diode aligns with the stripe printed on the circuit board outline.

Then solder all 4 leads. Once all leads have been soldered, cut the excess leads flush with the solder joint using your diagonal cutters.

- 13 Insert each of the 2 **1N5711 Schottky diodes** at their locations: **D1 and D2**.

Important! - Ensure that the black stripe on each diode aligns with the stripe printed on the circuit board outline.

Then solder all 4 leads. Once they have been soldered, cut the excess leads flush with the solder joint using your diagonal cutters.

- 14 Insert the 2-conductor JST XH PCB Header in the location marked **CN1**. Orient the header as shown in the image to the right. Solder both pins. No need to cut off the excess as these pins will not protrude far beyond the bottom of the circuit board.

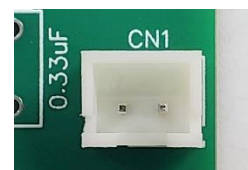

- 15 Insert one of the 10 pin female headers at the location marked: **H1**.

Turn the circuit board over while holding the header in place, and carefully lay the board down on the work surface. Ensure that the 10 pins are still protruding through the circuit board. The weight of the board should ensure that the connector will remain in place while you solder the pins.

Solder **one of the pins** while ensuring that the connector remains flush AND perpendicular with the circuit board. Then solder the remaining 9 pins before moving to the next step.

Important Tip: It is much easier to adjust the positioning of the 10-pin header while only one of the pins have been soldered. Make sure that the header is perpendicular to the circuit board as well as aligned with the header's white outline on the surface of the circuit board before soldering the remaining 9 pins. If need be, reheat the solder connection while manipulating the header in position with your other hand.

- 16 Repeat step 15 for the 10 pin female header at the location marked: **H2**.

17 Insert one of the 5 pin female headers at the location marked: **H4**.

- Turn the circuit board over while holding the header in place, and carefully lay the board down on the work surface. Ensure that the 5 pins are still protruding through the circuit board. The weight of the board should ensure that the connector will remain in place while you solder the pins.

Solder **one of the pins** while ensuring that the connector remains flush AND perpendicular with the circuit board. Then solder the remaining 4 pins before moving to the next step.

Important Tip: It is much easier to adjust the positioning of the 5-pin header while only one of the pins have been soldered. Make sure that the header is perpendicular to the circuit board as well as aligned with the header's white outline on the surface of the circuit board before soldering the remaining 4 pins. If need be, reheat the solder connection while manipulating the header in position with your other hand.

18 Repeat step 17 for the 5 pin female header at the location marked: **H5**.



19 Insert the 2 pin female header at its location marked: **H3**.

- Turn the circuit board over while holding the header in place, and carefully lay the board down on the work surface. Ensure that both of the pins are still protruding through the circuit board. The weight of the board should ensure that the connector will remain in place while you solder the pins.

Solder **one of the pins** while ensuring that the connector remains flush AND perpendicular with the circuit board. Then solder the remaining pin before moving to the next step.

Important Tip: It is much easier to adjust the positioning of the 2-pin header while only one of the pins have been soldered. Make sure that the header is perpendicular to the circuit board as well as aligned with the header's white outline on the surface of the circuit board before soldering the remaining pin. If need be, reheat the solder connection while manipulating the header in position with your other hand.

20 Insert a **14 pin IDC header** at the location marked: **CN2**.

- Important!** - Ensure that the notch in the connector aligns with the notch on the printed outline.

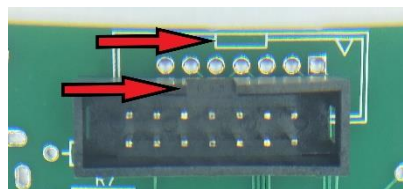

Turn the circuit board over while holding the connector in place, and carefully lay the board down on the work surface. Ensure that the 14 pins are still protruding through the circuit board. The weight of the board should ensure that the connector will remain in place while you solder the pins.

Solder one of the pins while ensuring that the connector remains flush with the circuit board. Then solder the remaining 13 pins before moving to the next step.

- 21 Insert each of the 8 **2N7000 N-channel MOSFETs** at their respective locations: **Q1, Q2, Q3, Q4, Q5, Q6, Q7, and Q8**.

Important! - Ensure that the flat side of the MOSFET aligns with its outline on the circuit board. Also, use as little solder as necessary when soldering each lead as the pads are very close together. Using too much solder may cause short circuits between the leads. After soldering, use a magnifying glass to inspect your work to ensure clean space between the leads.

Note: the MOSFETs will sit approximately 3/32" above the circuit board when properly inserted – this is expected.

Solder all 24 leads. Once all leads have been soldered, cut the excess leads flush with the solder joint using your diagonal cutters.

- 22 Insert the **78L08 8V Linear Voltage Regulator** in its location: **U1: 8V Reg**.

Important! - Ensure that the flat side of the voltage regulator case aligns with its outline on the circuit board.

Then solder all 3 leads. Once all leads have been soldered, cut the excess leads flush with the solder joint using your diagonal cutters.

Note: the following two steps are only for kits purchased AFTER 7/23/2023. If your kit was purchased PRIOR to that date, please ignore the following two steps.

- 23 Prepare the **LM7805 5V Linear Voltage Regulator** by installing the **TO-220 Heat Sink** using the screw provided with the heat sink. Refer to the image below for guidance:

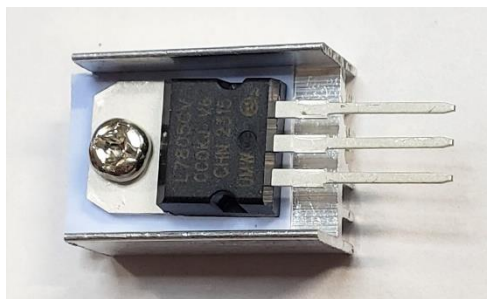

- 24 Insert the **LM7805 5V Linear Voltage Regulator** in its location: **U2: 5V Reg**. Ensure that the bottom of the **TO-220 heat sink** remains clear of capacitors **C3** and **C4** by mounting it about 3/16" to 1/4" above the circuit board.

Important! - Ensure that the "Tab" side of the voltage regulator case aligns with its outline on the circuit board. This means that the heat sink's "fins" will be pointing AWAY from the MCU headers (H1 & H2).

Then solder all 3 leads. Once all leads have been soldered, cut the excess leads flush with the solder joint using your diagonal cutters.

Note: The following step is only for kits purchased PRIOR to 7/23/2023. If your kit was purchased AFTER that date, please ignore the next step.

- 25 Insert the **78L05 5V Linear Voltage Regulator** in its location: **U2: 5V Reg.**

Important! - Ensure that the flat side of the voltage regulator case aligns with its outline on the circuit board.

Then solder all 3 leads. Once all leads have been soldered, cut the excess leads flush with the solder joint using your diagonal cutters.

- 26 Solder both leads from one end of the **6" x 2 conductor twisted pair cable assembly** to the **Toggle Switch**. It doesn't matter which color wire goes to which solder lug – just solder one wire to each lug.

Once complete, set the switch aside for later installation in the Final Assembly section.



- 27 Insert the short pins of the 2 **5-pin male pin headers** into the underside of the **Analog-to-digital converter (ADC)** module as shown in the image to the right.

Turn the module over while holding the headers in place, and carefully lay it down on the work surface. Ensure that the 10 pins are still protruding through the circuit board. The weight of the board should ensure that the connector will remain in place while you solder the pins.

Solder **one of the pins** on each header while ensuring that the connector remains flush AND perpendicular with the circuit board. Then solder the remaining 8 pins before moving to the next step.



Important Tip: It is much easier to adjust the positioning of each 5-pin header while only one of its pins has been soldered. Make sure each header is perpendicular to the circuit board as well as aligned with the header's white outline on the underside of the module before soldering the remaining 4 pins. If need be, reheat the solder connection while manipulating the header in position with your other hand.

Once complete, set the ADC module aside for later installation in the Final Assembly section.

The remaining circuit board assembly steps will be performed by inserting the components on the **UNDERSIDE** of the circuit board.

28 Insert each of the 2 **1 k Ω trimmer resistors (X 102)** at their respective locations: **R13 and R16**.

Turn the circuit board over while holding the trimmer resistors in place, and carefully lay the board down on the work surface. Ensure that all 6 pins are still protruding through the circuit board.

Solder **one of the pins** on each trimmer resistor while ensuring that their bodies remain flush with the circuit board and are aligned with the white outlines on the underside of the circuit board. Then solder the remaining 4 pins before moving to the next step.

Once all leads have been soldered, cut the excess leads flush with the solder joint using your diagonal cutters.

Important Tip: It is much easier to adjust the positioning of each trimmer resistor while only one of its pins has been soldered. Make sure each trimmer resistor is perpendicular to the circuit board as well as aligned with its white outline on the underside of the circuit board before soldering the remaining 2 pins. If need be, reheat the solder connection while manipulating the trimmer resistor in position with your other hand.

29 Repeat step 28 for the 2 **5 k Ω trimmer resistors (X 502)** at their locations: **R12 and R15**.

30 Repeat step 28 for the 2 **20 k Ω trimmer resistors (X 203)** at their locations: **R11 and R14**.

31 Insert the **12VDC power jack** at the location marked: **J1**.

Turn the circuit board over while holding the power jack in place, and carefully lay the board down on the work surface. Ensure that all 3 “pins” are still protruding through the circuit board.

Solder one of the pins while ensuring that the **power jack remains flush with the circuit board, and the jack’s body aligns with the white outline on the surface of the circuit board**. If necessary, reheat the solder and adjust the position of the power jack. Then solder the remaining 2 pins before moving to the next step.

32 Insert the **3.5mm stereo jack** at its location: **J2**.

Turn the circuit board over while holding the stereo jack in place, and carefully lay the board down on the work surface. Ensure that all 5 pins are still protruding through the circuit board.

Solder one of the pins while ensuring that the **stereo jack remains flush with the circuit board, and the jack’s body aligns with the white outline on the surface of the circuit board**. If necessary, reheat the solder and adjust the position of the stereo jack. Then solder the remaining 4 pins before moving to the next step.

33 Insert the **USB-B socket** into its location: **USB1**.

Solder all 6 pins. No need to trim any of the pins as they are all short enough already.

- 34 Take time to inspect all the solder connections – preferably with a magnifying glass. Look for connections that may not have enough - or too much - solder. Be especially careful when examining Q1 – Q8 to ensure that there are no solder bridges between any of the three pads associated with each MOSFET.

Also double-check to ensure that the correct components (especially the resistors) were placed in their respective locations.

Once this final inspection is complete, set the board aside and move to the next section: **Controller Front Panel.**

TFT DISPLAY BOARD INTERFACE

The TFT display board interface is used to convert the ribbon cable IDC connector to the 14-position pin header that is supplied with the TFT graphics display. Please follow the instructions in the following steps to assemble the interface.

- 35 Insert the pins of the **14 pin female right-angle header** into the holes provided on the backside of **TFT Display Interface Circuit Board** as shown in the image below.

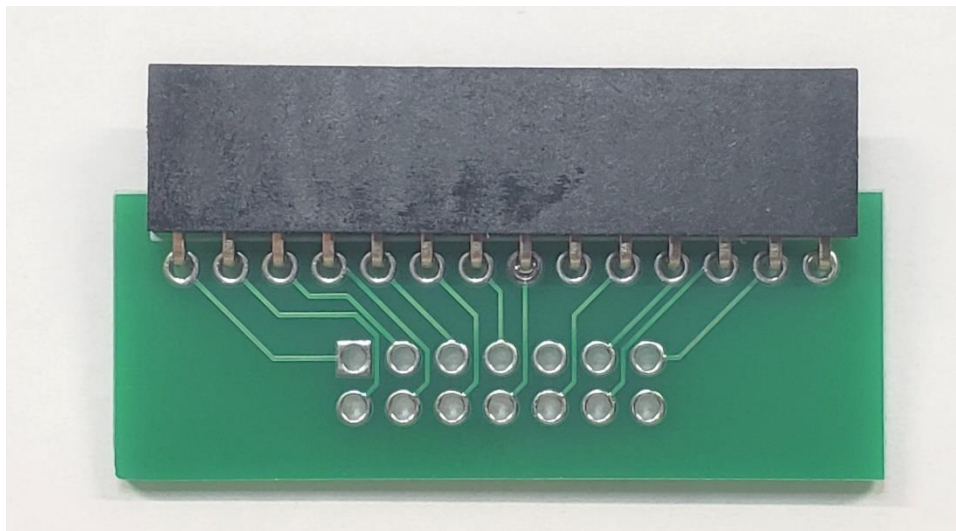

Turn the circuit board over while holding the header in place, and carefully lay the board down on the work surface. Ensure that all of the pins are still protruding through the circuit board. The weight of the board should ensure that the connector will remain in place while you solder the pins.

Solder one of the pins while ensuring that the connector remains **flush** with the circuit board. Then solder the remaining 13 pins before moving to the next step.

Important Tip: It is much easier to adjust the positioning of the header while only one of the pins has been soldered. Make sure that the header is perpendicular to the circuit board as well as aligned with the header's white outline on the surface of the circuit board before soldering the remaining 13 pins. If need be, reheat the solder connection while manipulating the header in position with your other hand.

- 36 Insert the other **14 pin IDC header** at its location on the top side of the **TFT Display Interface Circuit Board** as shown in the image below.

Important! - Ensure that the notch in the connector aligns with the notch on the printed outline.



Turn the circuit board over while holding the connector in place, and carefully lay the board down on the work surface. Ensure that the 14 pins are still protruding through the circuit board. The weight of the board should ensure that the connector will remain in place while you solder the pins.

Solder one of the pins while ensuring that the connector remains flush with the circuit board. Then solder the remaining 13 pins before moving to the next step.

SWR / POWER SENSOR BOARD

The following steps have been designed to make it easier for first-time kit builders to wind the sensor's toroid. The toroid utilizes bi-filar windings which make the job of keeping them neat and tidy more difficult. Neatness counts in this instance because the clearances are tight for inserting the finished toroid onto the brass tubing, and sloppy windings will encroach on this ability. Please read through the toroid winding steps (37 - 42) a couple of times until you are comfortable with the process.

- 37 To start the winding of the toroid, locate the red and green 26 gauge enameled wire and straighten them as best you can.

Place the ends together in your left hand while holding the toroid core in your right. Then, place the ends of the wires on top of the Toroid core so that about 1 inch is extended past the core as shown in the image below:

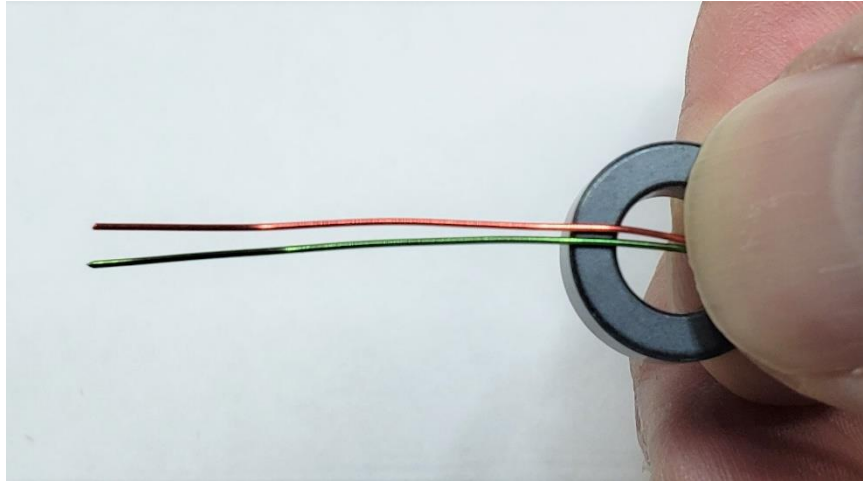

Take note that the red wire is on the top – it is important that, throughout the winding process, the orientation between the red and green wires stays the same.

- 38 Next, carefully insert the opposite ends of the wires down through the center of the toroid core and wrap them around the core so that they are back to the top as shown in the image below.

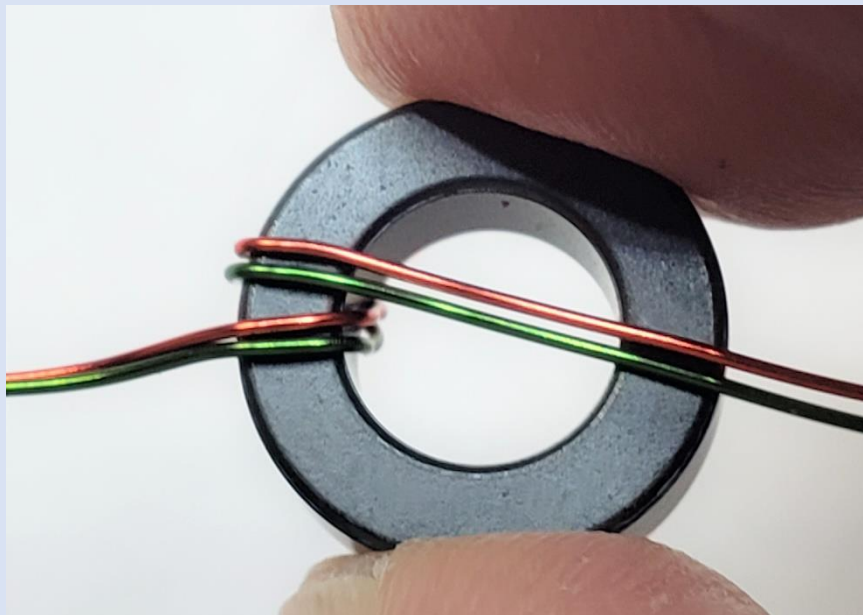

This constitutes one turn. Also notice that the red and green wires maintain their orientation to one another – that is, they have not overlapped. Once again, it is important to maintain this orientation throughout the remainder of the winding process.

- 39 In the same manner, continue to wind the toroid for 11 more turns – 12 turns in total. Keep in mind that one turn is represented by the wires passing through the center of the toroid from top to bottom. For instance, the image below shows three completed windings:

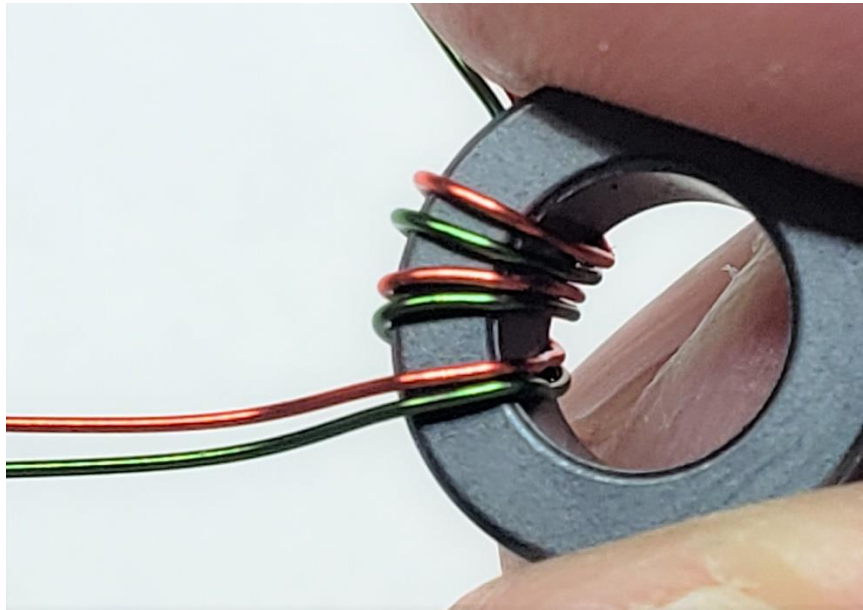

- 40 Once you have completed 12 turns, trim the excess wire so that about 1 inch remains. Arrange the wires as shown in the image below:

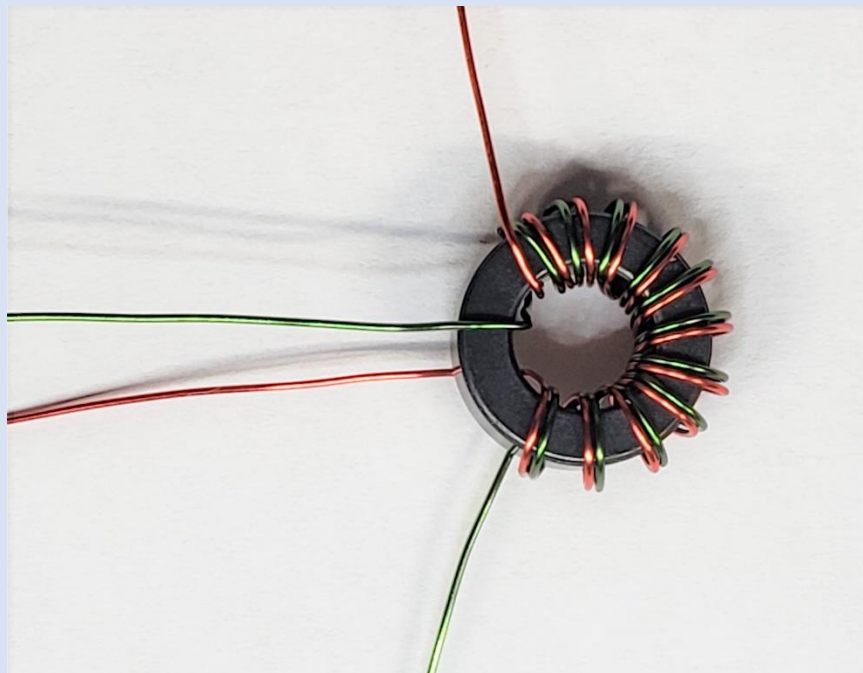

The green wire from turn #1 and the red wire from turn #12 will be twisted together in the next step to create the toroid's center tap.

- 41 Next, use the 500 grit silicon carbide sandpaper to gently remove the enamel from the center red and green wires as shown in the image below:

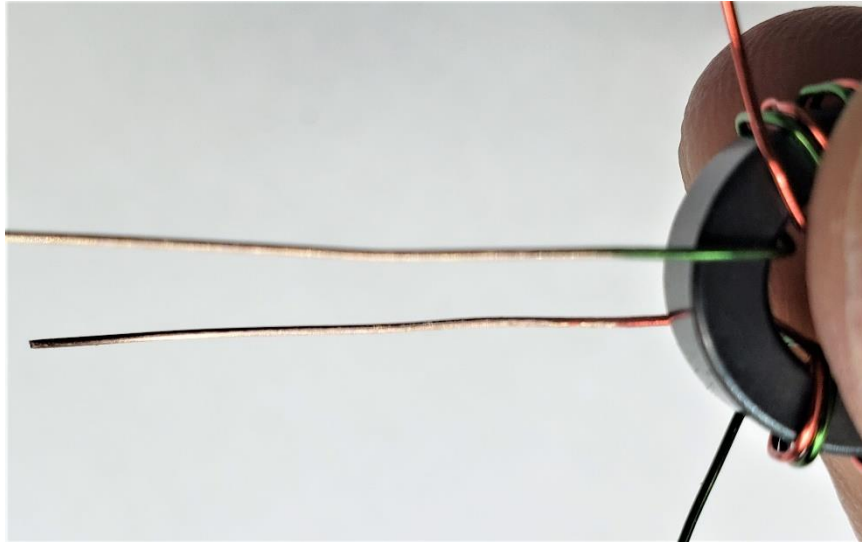

Caution: Be careful not to rub too hard so as not to erode the underlying wire much. It is OK to scratch it a little, but you don't want to make it so thin that it will break.

- 42 Finally, twist the two center wires together and apply a small amount of solder to ensure that they are adequately connected together. Please refer to the image below for a good example of how the toroid should look after completing the winding process:

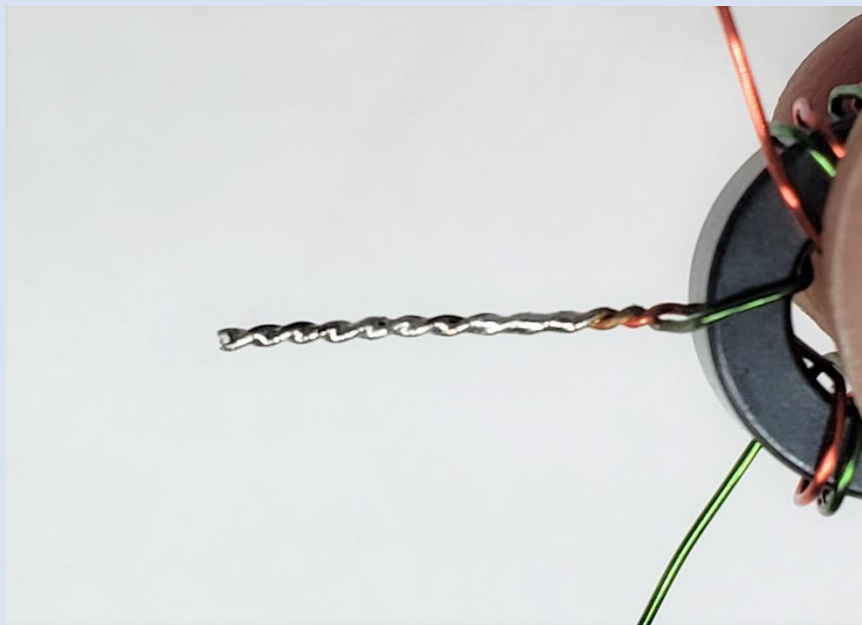

Set the finished toroid aside – it will be installed on the circuit board later.

The following steps (43 - 46) will guide you through the alignment and soldering of the brass tubing to the SWR / power sensor circuit board. A wooden jig has been included in the kit to make the alignment and subsequent soldering as easy and straightforward and possible. In order to adequately solder the brass tubing, your soldering iron must be capable of not only reaching at least 400 °F (204 °C), it must also be able to transfer that heat to both the circuit board trace as well as the brass tubing efficiently. Using a broader tip will help with the heat transfer. A soldering iron of at least 60W will also be a big help.

- 43 Place the wooden jig on a flat surface with the hole facing up. Insert the 7/16" brass tubing into the hole as shown in the image below:



- 44 Place the SWR / Power Sensor Circuit Board bottom-side-up onto the jig so that the brass tubing protrudes through the hole provided as shown in the image below:

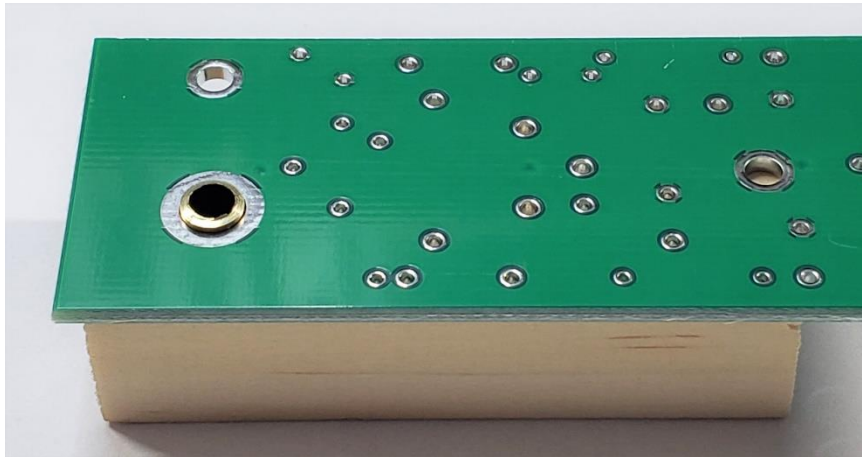

Approximately 1/16" to 1/8" of the brass tubing should be protruding through the bottom of the circuit board.

- 45 Solder the tubing to the circuit board by placing your soldering iron so that it contacts both the tubing as well as the solder pad on the circuit board – to allow for maximum heat transfer to both entities at the same time. It helps to dab a small amount of solder on your iron's tip as this will also aid in transferring heat to the tubing and circuit board pad. Please refer to the image below for guidance in placing the tip of your soldering iron:

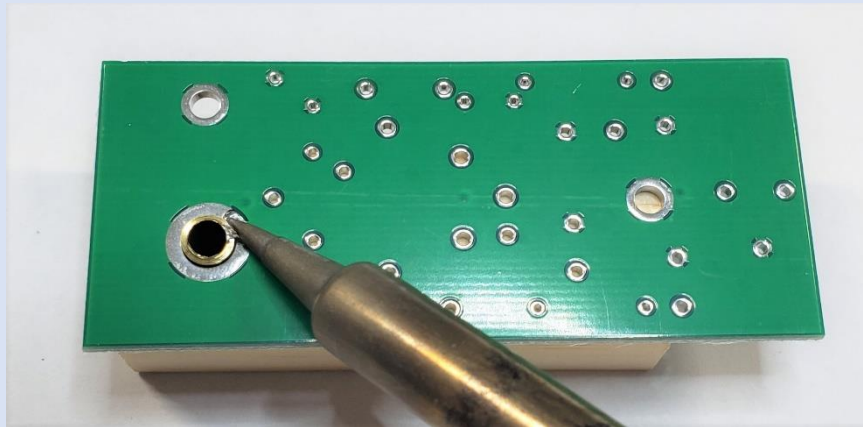

Rotate your soldering iron around the perimeter of the brass tubing while flowing the solder. Ensure that the tubing reaches a temperature that allows the solder to “flow” onto the tubing as well as the circuit board's solder pad.

Caution: At the same time, try not to prolong the application of heat as you may get to the point where the wooden jig will begin to smoke, and may catch fire. However, I've done this numerous times, and have yet to see this happen.

- 46 Once you have finished soldering the brass tubing to the circuit board, it should look similar to the images below:

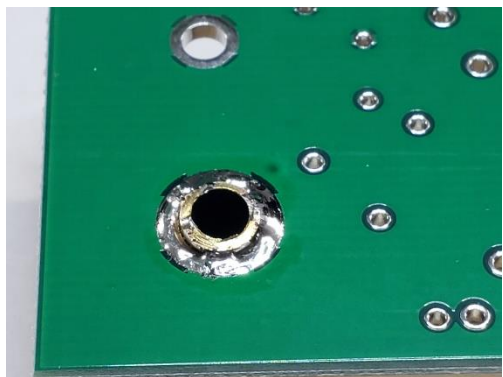

- 47 Use the 500 grit Silicon Carbide Sandpaper to dull the sharp outer edge of the brass tubing.

Important: The enamel covering the wire on the inner circumference of the toroid may be damaged if any sharp edges are left on the outer circumference of the brass tubing. This would cause erratic behavior due to possible short(s) to ground.

- 48 Retrieve the toroid that you set aside in step 42 and gently place it onto the brass tubing as shown in the image below:

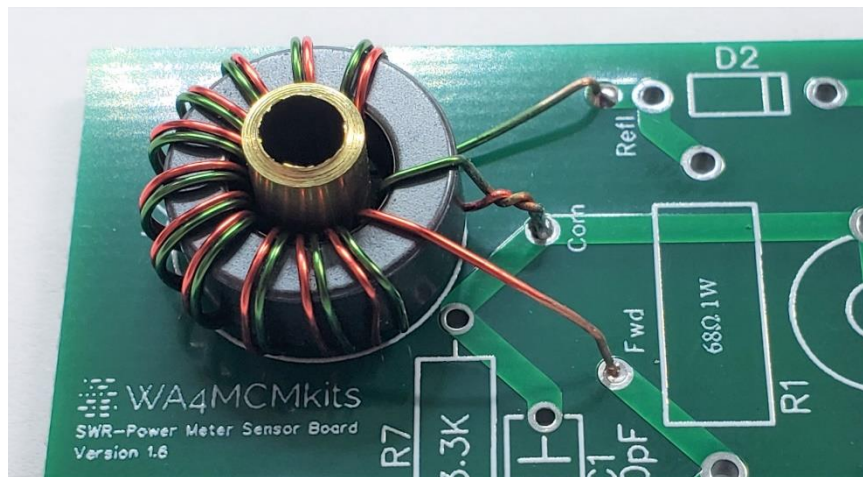

Insert the twisted center tap into the circuit board hole labeled “Com”.

Use the 500 grit silicon carbide sandpaper to remove the enamel from the remaining red and green wires. You only need to remove enough to allow for soldering the wires to their respective locations on the circuit board.

Insert the green wire into the hole labeled “RefI”.

Insert the red wire into the hole labeled “Fwd”.

Turn the circuit board over and solder all three wires. Once soldered, trim the excess wire using your diagonal cutters.

- 49 Insert each of the 2 **1N5711 Schottky diodes** at their locations: **D1 and D2**.

Important! - Ensure that the black stripe on each diode aligns with the stripe printed on the circuit board outline.

Then solder all 4 leads. Once they have been soldered, cut the excess leads flush with the solder joint using your diagonal cutters.

- 50 Insert the **3.3 k Ω ½ watt resistor (orange / orange / red / gold)** at its location: **R7**. Then solder both leads. Once all leads have been soldered, cut the excess leads flush with the solder joint using your diagonal cutters.

- 51 Insert the **68 Ω 1 watt resistor (blue / grey / black / gold)** at its location: **R1**. Then solder both leads. Once all leads have been soldered, cut the excess leads flush with the solder joint using your diagonal cutters.

- 52 Insert each of the 2 **470 Ω ¼ watt resistors (yellow / violet / brown / gold)** at their respective locations: **R2 and R3**. Then solder all 4 leads. Once all leads have been soldered, cut the excess leads flush with the solder joint using your diagonal cutters.

- 53 Insert 4 **1 nf Ceramic Disk Capacitors (102K)** at their locations: **C3, C4, C5, and C6**. Then solder all 8 leads. Once all leads have been soldered, cut the excess leads flush with the solder joint using your diagonal cutters.

54 Insert the **150 pf Ceramic Disk Capacitor (151)** at its location: **C1**. Then solder both leads. Once all leads have been soldered, cut the excess leads flush with the solder joint using your diagonal cutters.

55 Insert the **120 pf Ceramic Disk Capacitor (121)** at its location: **C2**. Then solder both leads. Once all leads have been soldered, cut the excess leads flush with the solder joint using your diagonal cutters.

56 Insert the **2.5 - 22 pf Trimmer Capacitor** at its location: **C14**. Then solder all 3 "leads". There is no need to trim the excess "leads" as they are all short enough already.

57 On the upper side of the circuit board, locate SP1 (solder point 1) – also marked C12. Refer to the image to the right for its location next to the trimmer capacitor (C14).

Turn the board over and identify the empty hole that corresponds to SP1. Trim one leg of the **82 pf Ceramic Disk Capacitor (82J)** so that it is approximately 7/8" long. Insert this leg into the hole identified as SP1 on the underside of the circuit board such that only a very small piece protrudes beyond the upper side of the circuit board and solder it in place. Refer to the image below for guidance on the capacitor's

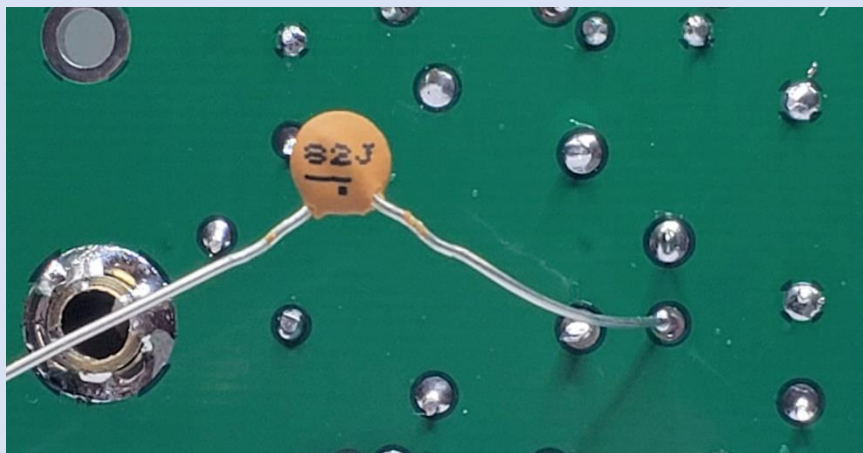

placement:

The other leg of this capacitor will be connected during the **Final Assembly** section.

- 58 On the upper side of the circuit board, locate **SP2 (Shld)**, **SP3 (Refl)**, and **SP4 (Fwd)**.
- Take the 6" length of **24ga insulated hookup wire** and cut it into 3 pieces of the following lengths:
- (1) 1 1/4"
 - (2) 1"

Trim about 3/16" of insulation from one end of each piece of wire. Trim about 5/16" of insulation from the other end of each piece of wire.

Insert the 5/16" stripped end of the 1 1/4" wire into a **FT-43-101 Ferrite Bead** and then into **SP2**. Solder and trim any excess wire protruding beyond the bottom of the board. Repeat for the remaining two 1" wires at **SP3** and **SP4**. Refer to the image below for guidance on each wire's placement:

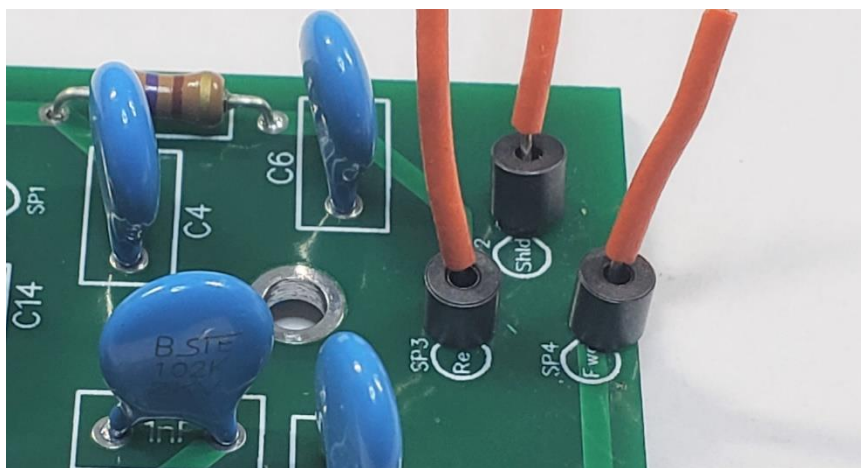

The other ends of these wires will be connected to the 3.5mm stereo jack during the **Final Assembly** section.

- 59 Take time to inspect all the solder connections – preferably with a magnifying glass. Look for connections that may not have enough - or too much - solder.
- Once this final inspection is complete, set the board aside and proceed to the next section- **Final Assembly**.

FINAL ASSEMBLY

METER ENCLOSURE

INSTALL THE MCU, OPAMP AND ADC MODULES

The ESP32-S3 MCU Module contains the computer code (firmware) that controls the operation of SWR & Wattmeter. This module comes fully assembled and tested due to the complexity associated with assembling its many surface-mount components. Its installation is straightforward due to the configuration of its 3 pin headers.

The Analog-to-digital converter (ADC) Module converts forward and reflected power voltages received from the power sensor assembly and then converts them to digital data that is readable by the MCU Module. It is possible to install this module upside down, so please pay close attention to the instructions in the following installation steps.

- 60 Locate pin 1 on the **LM324 Quad OpAmp** – it is marked with a small dot. Align pin 1 with the corresponding dot next to the IC socket marked U3 on the main board. Carefully insert the OpAmp's pins into their respective receptacles on the socket – you may have to slightly bend the pins inward in order to get them to fit – then gently push the OpAmp into the socket until it has been fully seated. Please refer to the following image for guidance:

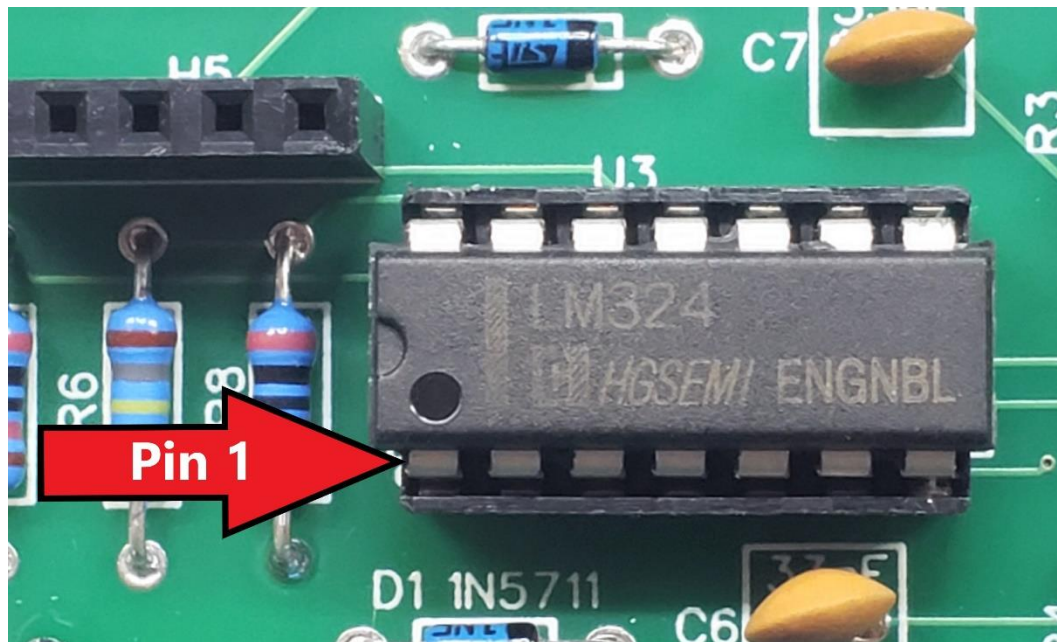

- 61 Locate the pin labeled **Pin 1** on the **Analog-to-digital converter (ADC) Module**. Orient this pin so that it corresponds to the Pin 1 label on the left end of header H4 on the main board. Gently insert the module all the way into the two headers (H4 and H5). Please refer to the image below for the proper alignment:

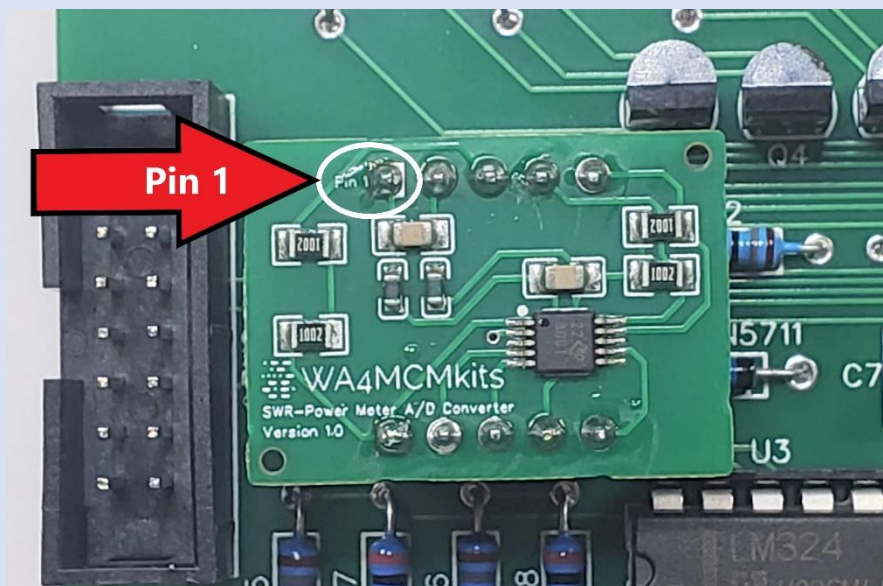

- 62 Align the pins of the three headers on the underside of the ESP32-S3 MCU Module with the mating headers on the upper right side of the main circuit board, and then gently press the module into the main board's headers. Please refer to the following image:

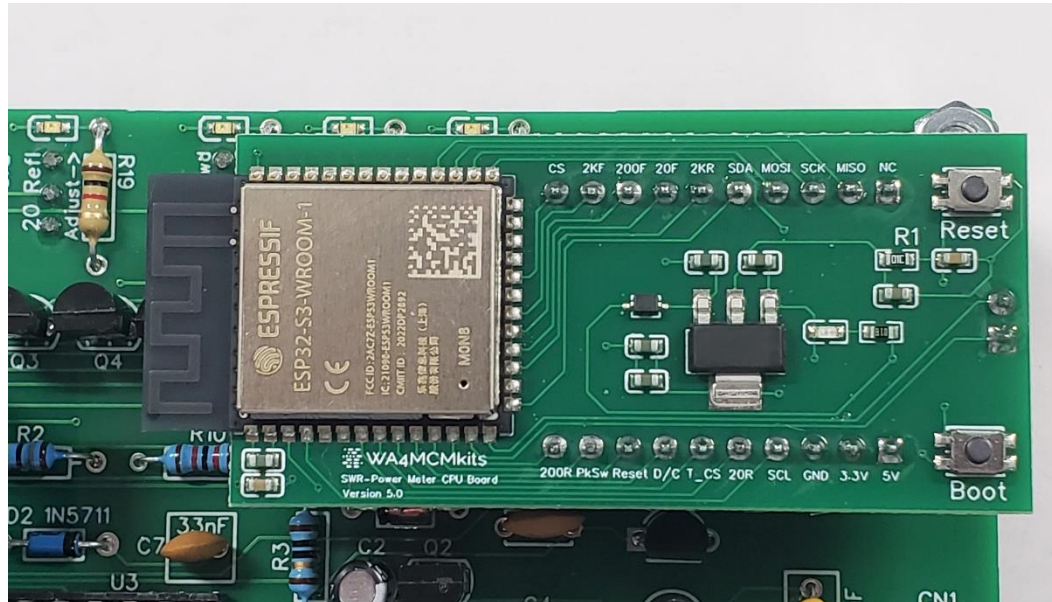

- 63 Set the main board aside – it will be installed later in this section.

TFT DISPLAY MODULE

The TFT Display Module is mounted to the front panel by inserting the TFT Display/Bezel assembly into the front panel cutout. The TFT Display/Bezel assembly is held in place by a special locking key that uses friction to remain in place during normal meter operation. Please complete the following steps to mount the TFT Display Module in the meter's enclosure.

- 64 **NOTE: This step may not be necessary as newer kits are being shipped with the TFT Display Module already inserted into the Front Panel Bezel. If your kit came this way, please disregard this step, and proceed to the next step.**

If a protective plastic layer still exists on the face of the TFT Display Module, remove it. Carefully slide the TFT display into the channel on the back side of the front panel bezel. Refer to the picture below and insert the end of the TFT display that contains the 14-pin male connector into the end of

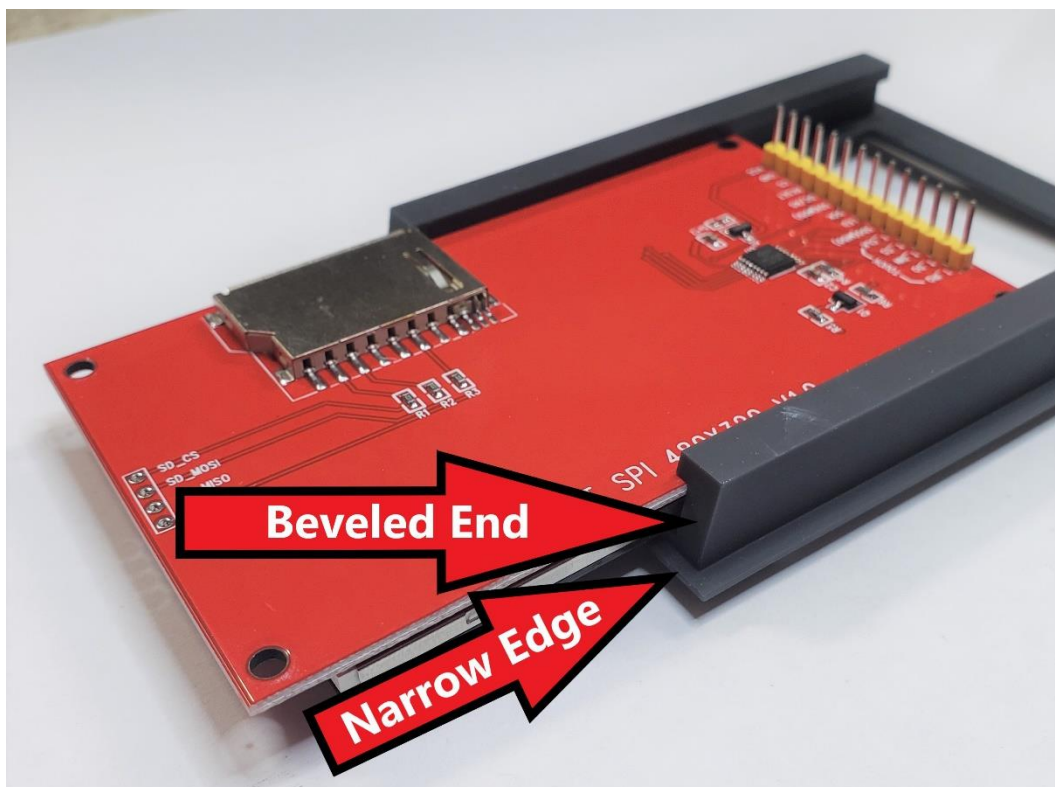

the bezel whose slotted rails are beveled. Slide the TFT Display Module so that the connector end protrudes beyond the slotted rails by about one half inch.

- 65 Carefully insert the left end of the TFT Display/Bezel assembly into the front panel cutout as shown in the image below. Be very careful not use too much pressure – the front of the TFT display will be in direct contact with the back side of the enclosure’s front face.



Once the left side of the TFT Display/Bezel assembly has been fully inserted and the left edge of the bezel is tight against the left side of the front panel cutout, carefully press the right side of the TFT/Bezel assembly into the right side of the front panel cutout. It should be snug, but not tight. Finally slide the TFT Display Module to the right slightly so that its left edge is about $\frac{1}{8}$ " from the inside left side of the enclosure. Refer to the image below for what it should ultimately look like:



- 66 The left side of the TFT Display/Bezel assembly is held in place by the left edge of the TFT Display Module itself. The right side of the TFT Display/Bezel assembly is held in place by the Display Assembly locking key.

First, identify the face of the locking key which has the 0.4mm “bump” running along one of the long edges of the key – this face will be facing the back side of the enclosure’s front panel and the “bump” should be closest to the right side of the enclosure. With the key properly oriented, slide it into position from the top of the enclosure. Refer to the image below for guidance:

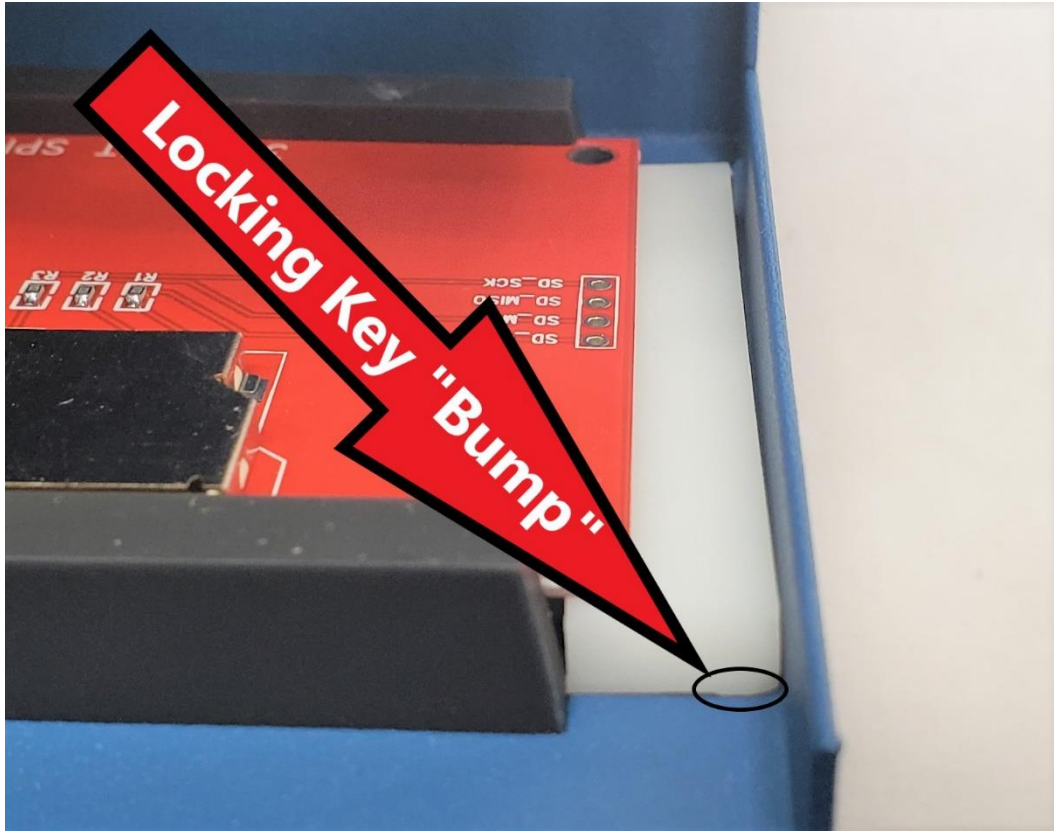

- 67 Once the locking key is in position and aligned with the inner sides of the bezel's channels as shown in the previous step's image, use a small straight-slot screwdriver to push it to the left such that it slides further under the TFT Display Module until the locking key is snug enough to remain in place due to friction. The friction should be enough to hold the locking key in place during normal operation of the SWR & Wattmeter. However, you may use a small piece of tape to hold it if needed. Please refer to the following image showing the final placement of the locking key:

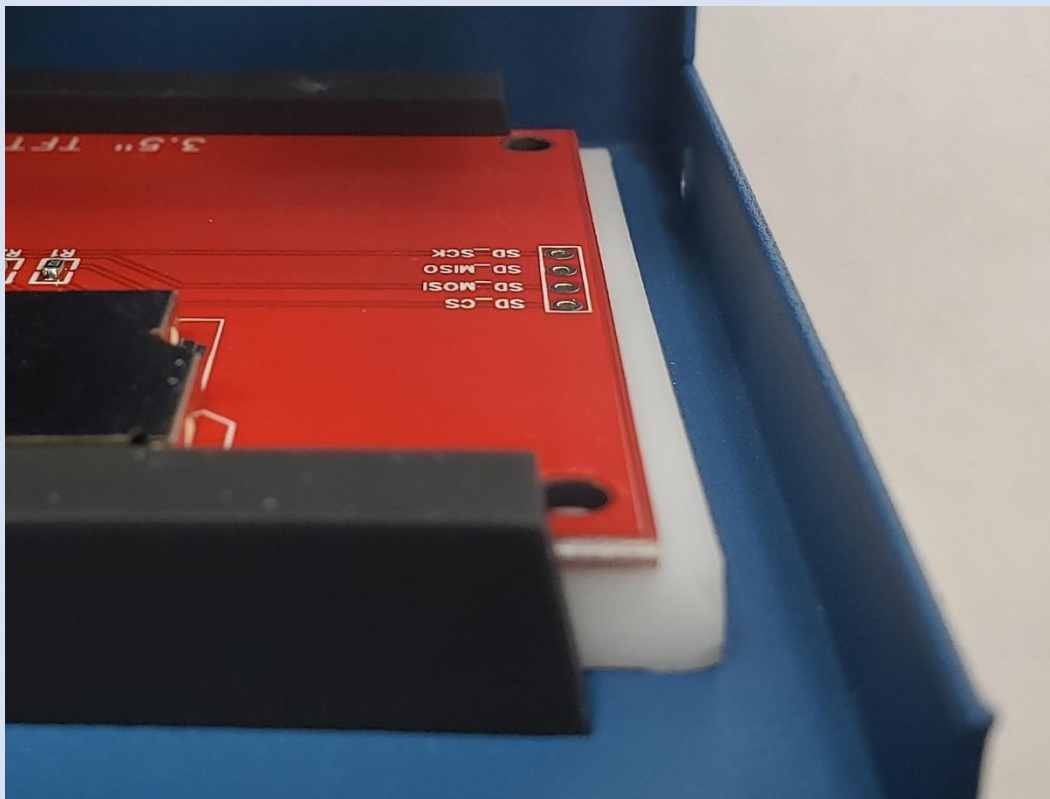

SWR & WATTMETER MAIN BOARD

The main circuit board is mounted using 4 threaded standoffs. The three under-side connectors are designed to fit through the rear panel cutouts.

- 68 Insert the male end of four 4-40 X 1/2" standoffs into the holes provided on each corner of the main circuit board – insert them from the bottom of the circuit board and secure them with 4-40 hex nuts.
- 69 Place the circuit board against the inside back of the enclosure such that the three jacks (USB, Power, and 3.5mm Stereo) protrude through their respective cutouts.
- 70 Attach the main circuit board using a 4-40 x 1/4" pan head screw at each standoff.

POWER SWITCH AND RIBBON CABLE

- 71 Prepare the toggle switch by removing the outer nut and the lock washer and position the inner nut about halfway down the threaded collar as shown in the image to the right.

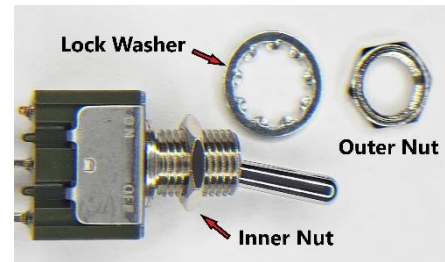

- 72 Insert the switch into the 1/4" rear panel hole aligned as shown in the image to the right. Make sure that the "On" position is pointing up.

Secure it by first placing the lock washer on the collar, then screw and tighten the outer nut while holding the body of the switch to prevent twisting.

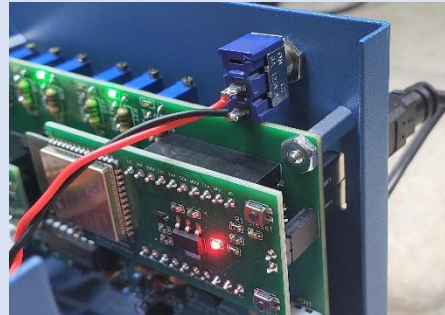

- 73 Plug the toggle switch's connector into its socket (CN1) located on the main circuit board. The connector will only fit when oriented such that the "key" fits in the "U" shaped cutout in the socket.

- 74 Plug one end of the 14-conductor ribbon cable into the **14-pin IDC connector (CN2)** on the left end of the SWR Meter's main circuit board. Plug the other end of the ribbon cable into the 14-pin IDC connector on the display interface board. Refer to the image below for guidance:



- 75 Plug the display interface board into the 14 pin header on the back side of the TFT Display. Be sure to observe and adhere to the “Up” arrow. Refer to the image below for guidance:

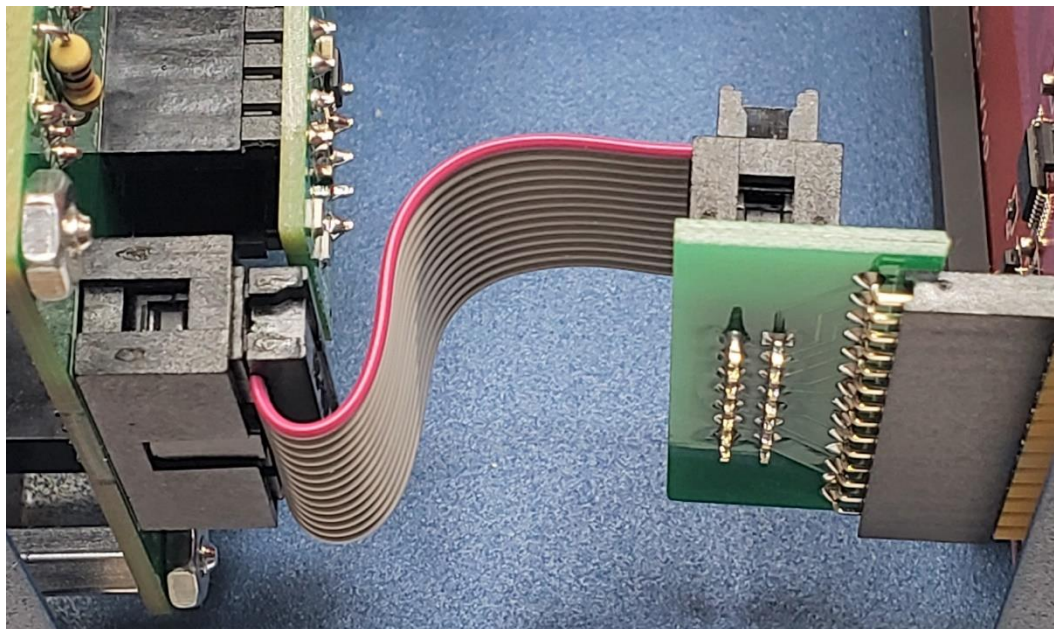

- 76 Install the 4 rubber feet that are provided with the enclosure.



POWER SENSOR BOX

The last assembly task of the SWR & Wattmeter is the assembly of the sensor unit which actually detects the forward and reflected power. This entails installing the (2) SO-239 RF connectors, then connecting them with the #14 solid copper wire while threading this wire through the center of the bifilar-wound toroid on the sensor circuit board. Finally, the circuit board is secured to the enclosure and the detected forward and reflected voltage leads as well as the common ground lead are connected to the 3.5mm stereo jack. The following section provides details on how to complete the power sensor's assembly.

- 77 Insert the male end of the two 4-40 X 7/8" standoffs into the holes provided on the sensor circuit board – insert them from the bottom of the circuit board and secure them with 4-40 hex nuts.



- 78 Install the two **SO-239 UHF Coax Connectors** in the 5/8" holes on either side of the sensor enclosure. Align the "U" shaped solder cups so that the cups are facing up as shown in the below. Tighten both connectors' nuts while ensuring the solder cups remain facing up.

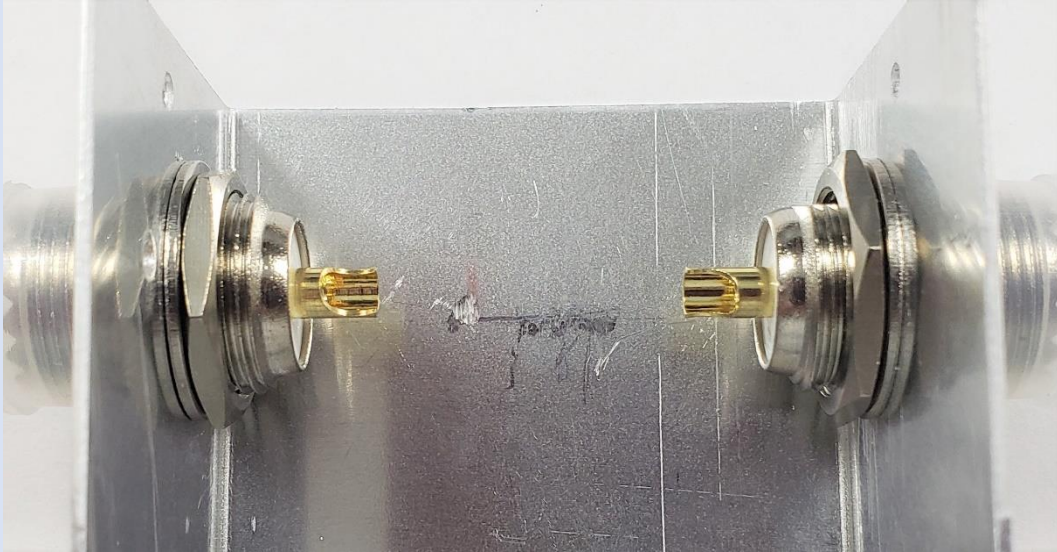

Tip: Screw a PL-259 adapter tightly to the SO-239 connector. Then use a pair of pliers to prevent the SO-239 UHF Coax Connector from spinning while tightening the connector's nut. The PL-259 will protect the threads of the connector from being damaged by the pliers. Please refer to the image shown below for guidance:



- 79 Install the **3.5mm Panel-mounted Stereo Jack** and tighten the mounting nut so that the solder lugs are oriented as shown in the image below.

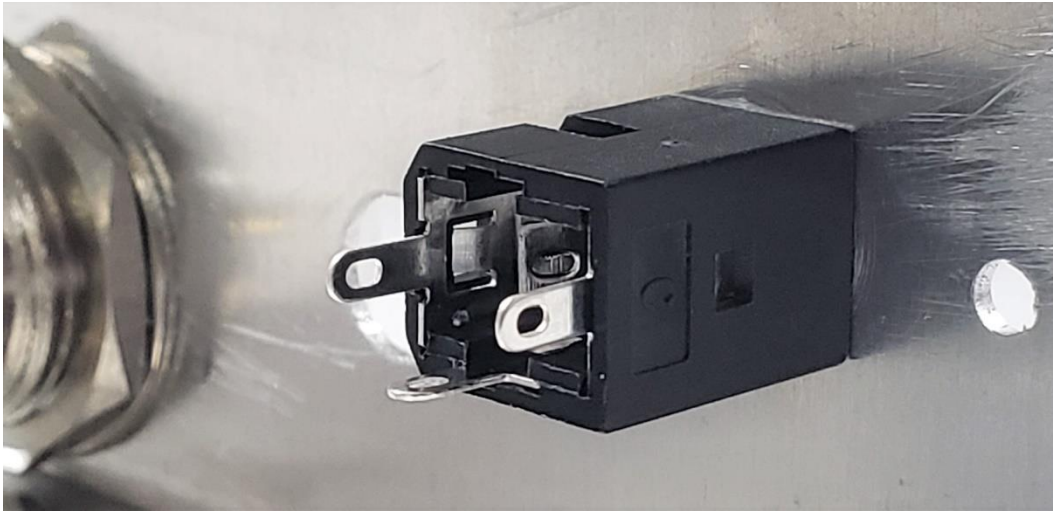

Caution: Ensure that you don't cross-thread the mounting nut – this is easy to do since the jack's body is plastic.

- 80 Prepare the **#14 THHN Solid Copper Wire** by trimming it to 1 1/4 inches long and strip 1/8" of insulation from each end. Dry fit the wire between the two **SO-239 UHF Coax Connectors** to ensure a good fit – adjust the length as needed to achieve a good fit. Refer to the image below for guidance:

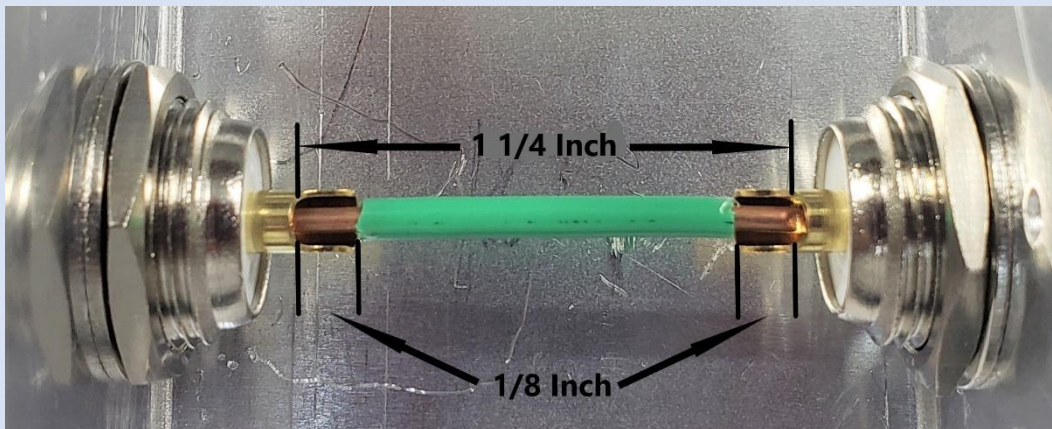

- 81 Thread the wire through the toroid on the sensor circuit board and place the wire on the **SO-239 UHF Coax Connectors** as shown in the image below:

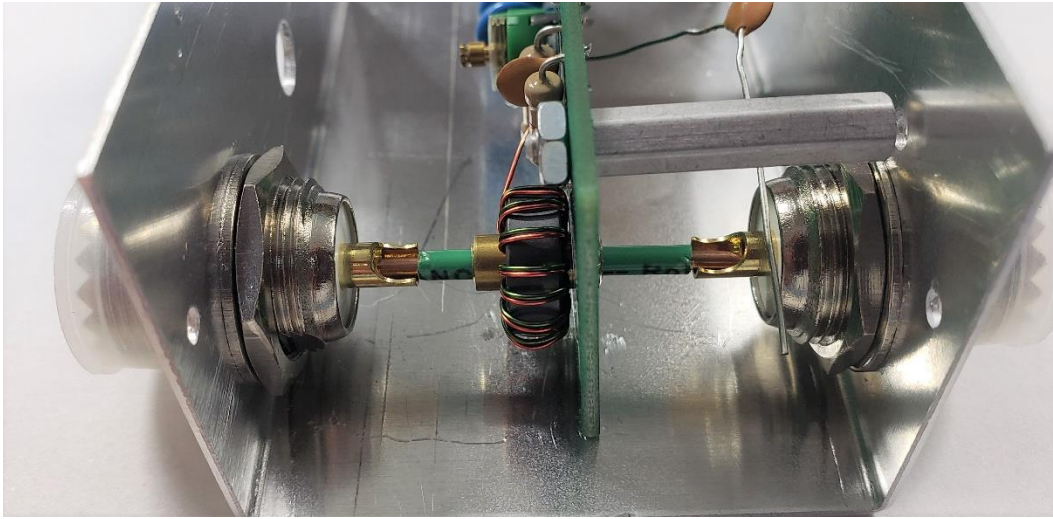

- 82 Secure the standoffs to the enclosure using two **4-40 x 1/4" pan head machine screws**.

- 83 Insert the end of the wire coming from **SP3 (Ref)** into the **3.5mm Panel-mounted Stereo Jack's** solder lug located closest to the end of the enclosure with the **SO-239 UHF Coax Connectors**.
Refer to the image shown in step 85 for proper placement.

- 84 Repeat step 83 for the wire coming from **SP2 (Shld)** – connect it to the **3.5mm Panel-mounted Stereo Jack's** solder lug closest to the bottom of the enclosure.
Refer to the image shown in step 85 for proper placement.

- 85 Repeat step 83 for the wire coming from **SP4 (Fwd)** – connect it to the **3.5mm Panel-mounted Stereo Jack's** remaining empty solder lug. Please refer to the following image for details on the final disposition of all three hookup wires:

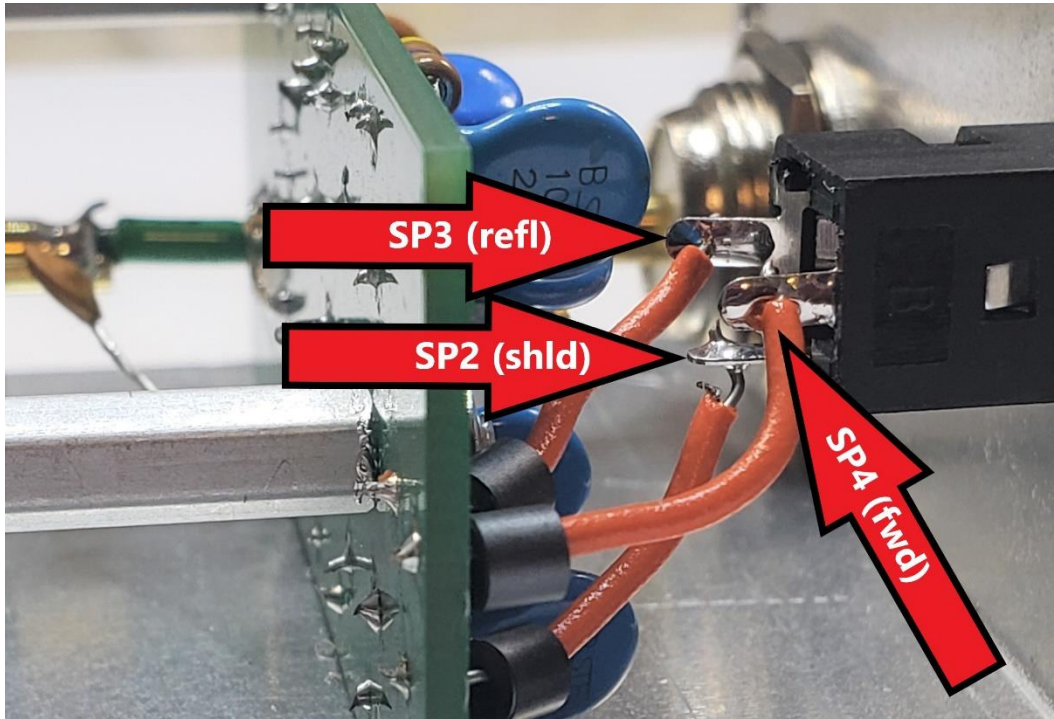

- 86 Solder the end of the **#14 THHN Solid Copper Wire** laying in the input connector's solder cup. Make sure that you apply enough heat to flow the solder. Refer to the image below for a properly soldered input connector:

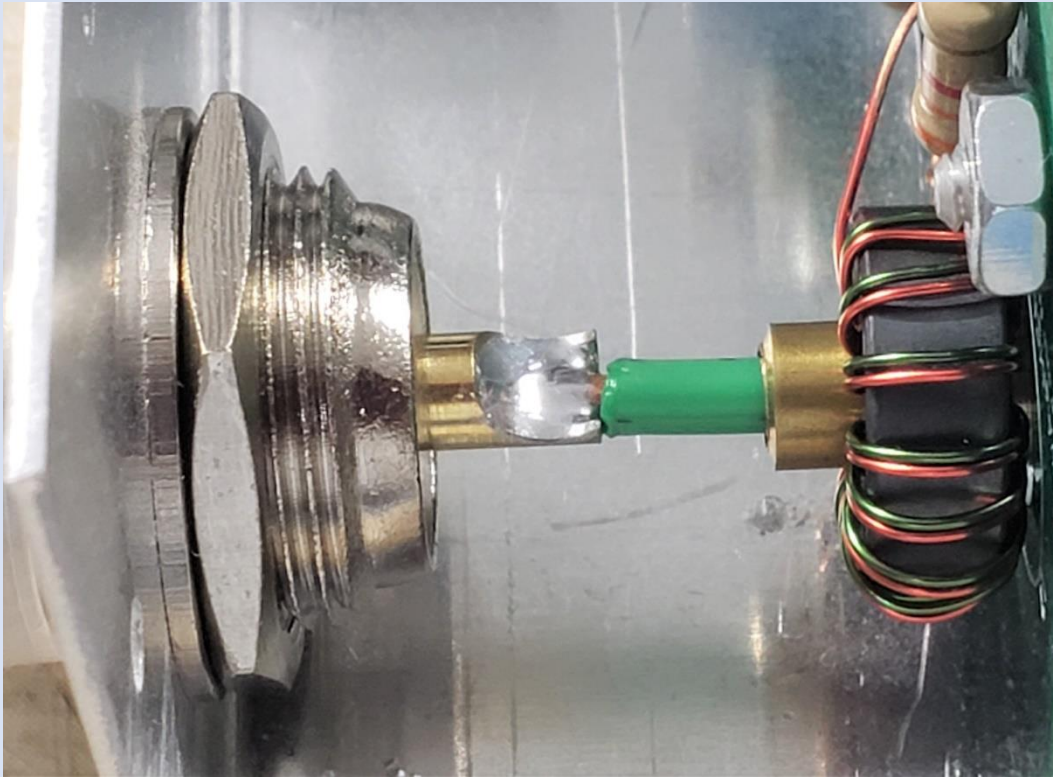

- 87 Trim the un-connected lead of C12 so that it does not extend beyond the output RF connector's solder cup and arrange it so that it lays on top of the solder cup as shown in the image below:

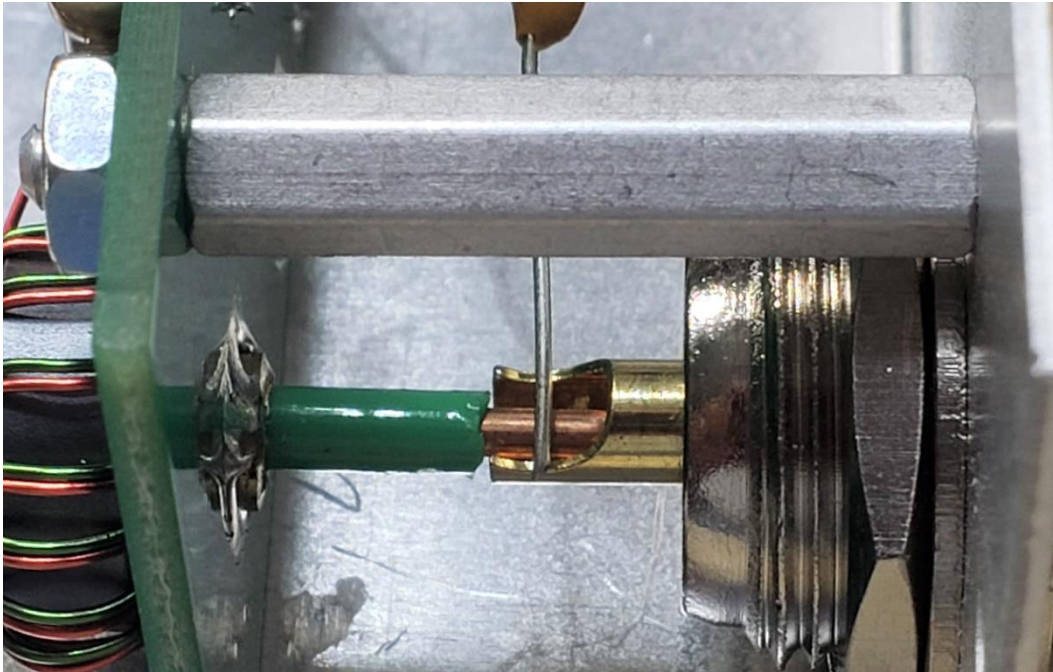

- 88 Solder the end of the **#14 THHN Solid Copper Wire** as well as the lead of C12 to the output connector's solder cup. Make sure that you apply enough heat to flow the solder. Refer to the image below for a properly soldered input connector:

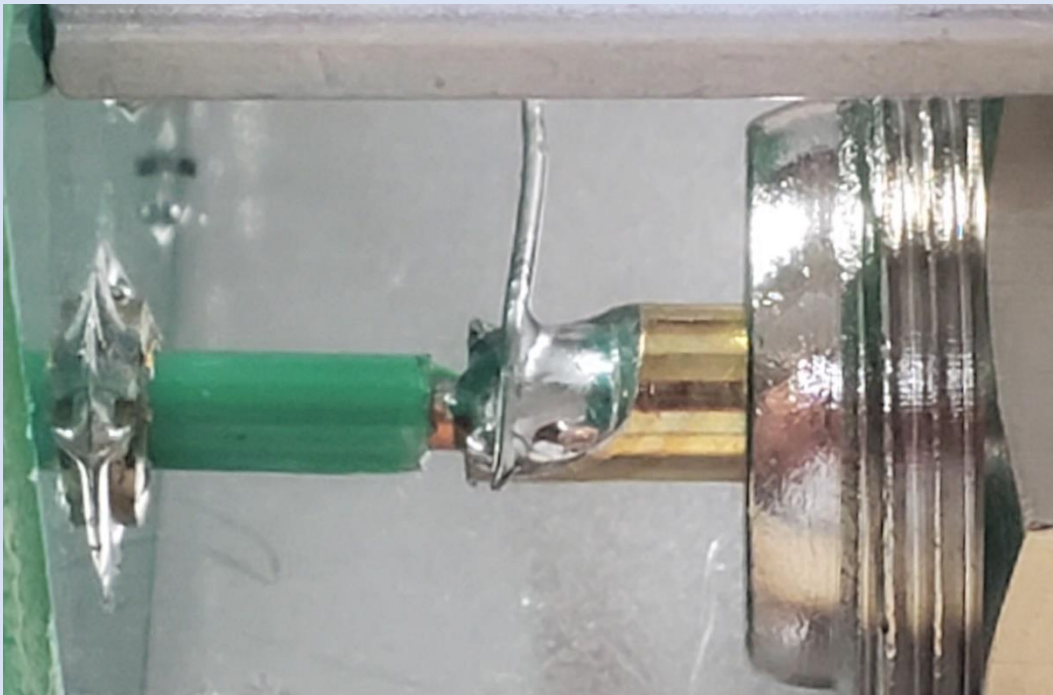

89 Perform a final check of all solder connections. Make sure that the forward and reflected output leads connected to the **3.5mm Panel-mounted Stereo Jack** are not shorted to any of the other solder lugs. Also ensure that the ferrite beads are not touching any of the other solder lugs.

90 Install the sensor assembly enclosure's cover using the four screws provided.

CALIBRATION AND TESTING

Before testing can begin, you will need to connect the 12VDC supply to the SWR & Wattmeter via the meter's back panel jack labeled: **12 VDC**.

You will also need to connect the power sensor assembly to the SWR & Wattmeter using the 5' Braided Stereo Cable. Connect one end of the cable to the sensor jack labeled: **To Meter**. Connect the other end of the cable to the SWR meter's back panel jack labeled: **Sensor**.

Finally, connect a coaxial cable between your transmitter and the **Input** RF connector on the sensor assembly. Connect a second coaxial cable between the **Output** RF connector and a 50Ω dummy load capable of handling your transmitter's full output power. **Set your transmitter to the 40 meter band – if your transmitter does not cover 40 meters, set it to the band you use the most.**

For a helpful video demonstration of this section's entire procedure, please check out the YouTube video at this link: [GM-102 SWR & Wattmeter Calibration Procedure](#)

If any of the adjustments listed below do not produce the expected results, proceed to the troubleshooting section for help.

SWR BALANCE ADJUSTMENT

Before any other adjustments can be performed, the sensor unit's SWR Bruene bridge circuit must be balanced. If this is not performed correctly, the accuracy of all other adjustments will be invalid.

- 91 On the meter's front display, press on the gear in the upper left-hand corner of the screen to open the settings menu. Click on the **SWR Null Cal** box – an "X" should appear to indicate that this mode has been selected.

Touch the **Save** button.

The SWR Null Cal mode sets the meter's display to the reflected power needle display with the scale set to the 20W full scale setting. It also changes the reflected power digital display precision to two decimal places.

Note: While in the SWR Null Cal mode, the ability to change these settings has been locked out until this mode has been turned off – either by manually doing so in the main settings menu, or by turning the meter off and then back on.

- 92 Set your transmitter so that it will transmit a 100 watt CW signal, or to its maximum power setting if that is less than 100 watts.

- 93 Using the non-conductive, straight slot alignment tool, increase the gain of the 20W Reflected power circuit by turning the adjustment screw of trimmer resistor R19 three turns counterclockwise when viewed from above.

Note: This trimmer resistor can easily be identified by the left-most green LED illuminated right in front of the adjustment screw.

- 94 Insert the alignment tool into the Balance Adjust hole on the sensor board and carefully feel around for the adjustment screw attached to trimmer capacitor C14. If needed, peer into the hole to visualize the location of this adjustment screw. Make sure the alignment tool's blade is fitted into the slot of the adjustment screw.

- 95 Key the transmitter and SLOWLY adjust the trimmer capacitor C14 to produce a null reading for the reflected power on the SWR meter. This adjustment is very touchy, so a light easy pressure on the alignment tool is needed to achieve the best null.

You may have to go back and forth several times to actually find the null. Most likely, the null will read as **0.00** watts for some number turn degrees of the alignment tool. In this case, try to set the null adjustment for the “center” of this region.

Be sure that you have adjusted C14 for the best null as described above before moving to the next section: *Power Scale Calibration*.

- 96 Reset the meter by turning the power off, then back on.

- Proceed to the next section: *Power Scale Calibration*

POWER SCALE CALIBRATION

The power scale calibration process consists of adjusting each scale’s OpAmp gain so that the meter’s reading matches the transmitter’s known power output into a 50Ω dummy load. How do I know the actual output power of my transmitter when my power meter hasn’t been calibrated yet, you ask? Good question – and one that I will try to answer in the following paragraphs. There are several ways to arrive at the actual power output using alternate test equipment. I will list these in decreasing order of accuracy below:

1. Use a calibrated wattmeter – Place a calibrated (or known, trusted) wattmeter in line with the GM-102 Wattmeter’s power sensor to use as a standard.
2. Use a calibrated RF probe coupled with a high input impedance voltmeter to measure the RF volts at the dummy load – you can use a “T” connector at the dummy load end of the cable if your dummy load doesn’t have a measurement port. To calculate the actual power, use the following formula:

$$\frac{V_{rms}^2}{50\Omega} = Output Power (Watts)$$

3. As a last resort, the forward power output voltage measured at the **3.5mm Panel-mounted Stereo Jack’s** forward power solder lug (the one labeled SP4 in the step 85 image) can be used to calculate the approximate power using the formulas below. However, there are several components on the sensor circuit board whose tolerances will cause this voltage to vary from kit to kit. Therefore, this method should only be used if you don’t have access (or can’t borrow) the test equipment noted in points 1 and 2 above.

For power levels close to 100 watts:

$$\frac{(V_{dc} \times 14.3)^2}{50\Omega} = Output Power (Watts)$$

For power levels close to 10 watts:

$$\frac{(V_{dc} \times 16.1)^2}{50\Omega} = Output Power (Watts)$$

In all cases, each scale’s adjustment should be made with the transmitter’s power set to the scale’s mid-range (e.g., 10W, 100W, 1000W) for the best accuracy. Also, your transmitter should be set to 40 meters if at all possible. If not, set it on the band you use most often. **Note: the ability to choose a different set of scale ranges**

has been introduced with firmware version 1.2.1. If you have opted to use the new 10W/100W/1000W set of scales, adjust your mid-range values accordingly.

- 97 Set your transmitter so that it will transmit a 10 Watt CW signal – or 5 Watts if using the new scales.



- 98 Touch the gear icon in the upper left corner of the meter's face and set the following:



- Meter Face Type to Bar Graphs

Press the Save Button.

- Touch the forward power bar graph until the forward power scale is set to the lowest scale (10W or 20W depending on your selected scale preference)
- Touch the reflected power bar graph until the reflected power scale is set to the lowest scale (10W or 20W depending on your selected scale preference)
- In the lower right corner of the meter face, touch the normal/peak hold label until it shows "normal".

- 99 Ensure that the LEDs on the top of the main circuit board match the image below:



The LEDs indicate which trimmer resistors will be adjusted for the following steps.

- 100 Key the transmitter and measure its output power using one of the methods described in the introduction to this section.



Adjust the trimmer resistor indicated by the right-most LED so that the digital forward power reading matches this value.

Unkey the transmitter so that it is no longer transmitting.

- 101 Reverse the coaxial cables on the power sensor so that the transmitter is now connected to the **Output** connector, and the dummy load is connected to the **Input** connector.



- 102 Key the transmitter and adjust the trimmer resistor indicated by the left-most LED so that the digital reflected power reading matches the value obtained in step 100.



Unkey the transmitter so that it is no longer transmitting.

- 103 Restore the coaxial cables to their previous connectors – transmitter to the **Input** connector and dummy load to the **Output** connector.



- 104 On the meter's face, touch the forward power bar to change its power scale to the middle scale (100W or 200W).



Likewise, touch the reflected power bar to change its power scale to the middle scale.

- 105 Ensure that the LEDs on the top of the main circuit board match the image below:

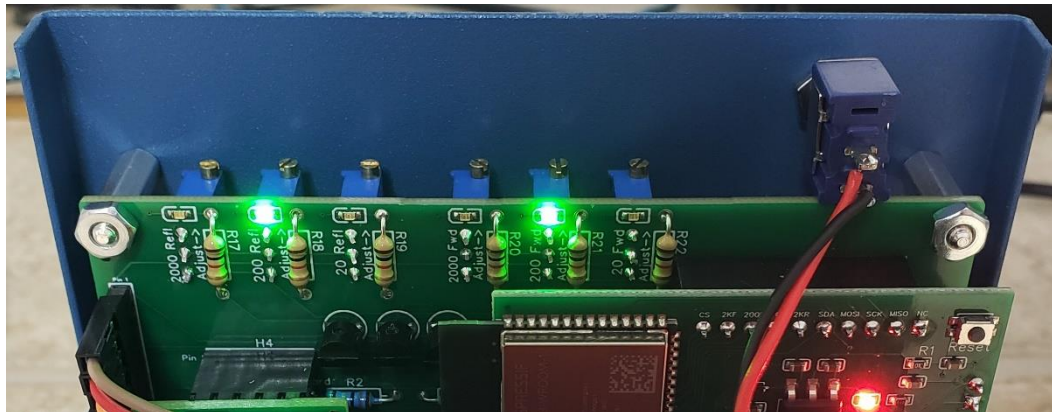

- 106 Set your transmitter so that it will transmit a CW signal at its maximum power output, or 100 Watts (or 50 Watts if using the new scales) – whichever is less.



- 107 Repeat steps 100 through 103 for this new power setting.



- 108 On the meter's face, touch the forward power bar to change its power scale to the highest scale (1KW or 2KW).



Likewise, touch the reflected power bar to change its power scale to the highest scale.

- 109 Ensure that the LEDs on the top of the main circuit board match the image below:



- 110 If your transmitter (or linear amplifier) is capable, set your output power so that you can transmit a CW signal at its maximum power output, or 1000 Watts (**or 500 Watts if using the new scales**)- whichever is less. If not, then leave it at its maximum power as set in step 106.
- 111 Repeat steps 100 through 103 for this new power setting.
- Proceed to the next section: *Peak Hold Test*

PEAK HOLD TEST

The peak hold function serves to prevent the radical movement of the meter while transmitting SSB. This will serve to provide a more accurate power reading without having to resort to whistling into the microphone.

This is accomplished by programmatically inserting a parallel RC circuit between the first and second OpAmp stages for each power type (forward or reflected). This RC circuit serves to maintain the input to the second OpAmp stage at a constant level while transmitting. The level will slowly diminish once transmitting is finished, or longer pauses in speaking.

Note: These instruction test the hardware peak hold circuitry as described above. If you have selected the firmware peak hold option, these steps will not apply. There are no tests needed for the firmware peak hold option.

- 112 Set your transmitter so that you can transmit a 100 Watt SSB signal (**or 50 Watts if using the new scales**).
- 113 On the meter's face, touch the forward power bar the number of times needed to change to the middle scale.
- 114 Key the microphone and speak in a normal voice. Notice that the bar meter bounces radically related to your voice and the words being spoken.
- 115 On the lower right corner of the meter's face, touch the word **Normal**. Note that this changes it to **Peak Hold**, indicating that the peak hold function has been activated.
- 116 Key the microphone and speak in a normal voice. Notice that the bar meter no longer bounces radically related to your voice or the words being spoken. Instead, it remains more or less at the same level which should be close to your transmitter's output power setting.
- 117 This concludes the calibration and testing of the GM-102 SWR & Wattmeter.
 You can put the meter enclosure's cover in place and secure it with the four 3mm pan head screws provide for this purpose.

TROUBLESHOOTING

Before reviewing Table 3 below for possible solutions to your problem, please take time to inspect the following items carefully and thoroughly:

- **Solder Joints** – Bad solder joints are the single most common cause of non-working electronics projects.
- **Correct diode polarity** – Make sure that the white (or black) band is pointing in the correct direction.
- **Electrolytic capacitor polarity** – Make sure that the negative lead (white band on the capacitor's side) of each capacitor is correct. This band should be facing the 2N7000 N-channel MOSFET to each capacitor's right.
- **Correct 2N7000 N-channel MOSFET placement** – Ensure that the MOSFET's cases match their outlines on the circuit board.
- **Correct voltage regulator placement** – Ensure their flat sides match their circuit board outlines.
- **Quad OpAmp is installed correctly** – Ensure that the notch is facing in the correct direction.
- **Analog to Digital Converter Module Installed Correctly** – Ensure that pin 1 on the module mates up with Pin 1 on the circuit board's header H4.

When reviewing the possible solutions in Table 3, all measurements are made between the point named in the text and chassis ground unless otherwise noted in the text. Likewise, any tests that require applying a voltage will be made referenced to chassis ground.

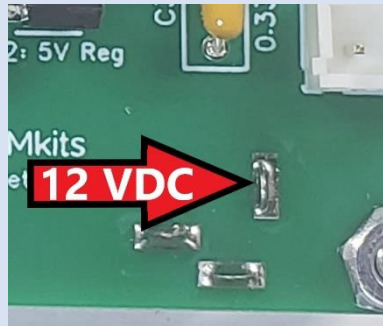
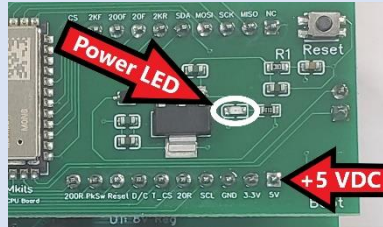

Table 3 - Troubleshooting Matrix

Symptom	Possible Solutions	
<p>No image on the display – MCU Board’s power LED is not illuminated.</p>	<p>Check for:</p> <ul style="list-style-type: none"> • Check for +5VDC on pin1 of header H2 on the MCU board. This voltage is used for the TFT Display’s backlight. See image below for measurement location. 	<p>If measurement is bad:</p> <ul style="list-style-type: none"> • Possible faulty U2: 5V voltage regulator • Possible short grounding the 5V power circuit.
	<ul style="list-style-type: none"> • Check for +12VDC on the DC power connector’s solder lug as shown in the image below: 	<ul style="list-style-type: none"> • Possible bad 12 VDC power supply or cable. • Possible faulty DC power connector (rare)
	<ul style="list-style-type: none"> • Check for +12VDC on both solder lugs of the on/off switch. 	<ul style="list-style-type: none"> • Possible bad switch if one lug has +12VDC and the other lug does not.

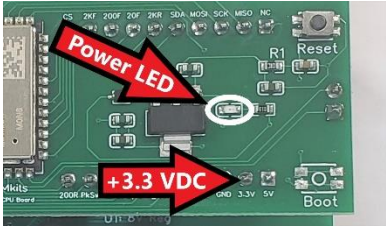

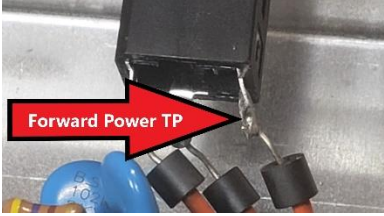
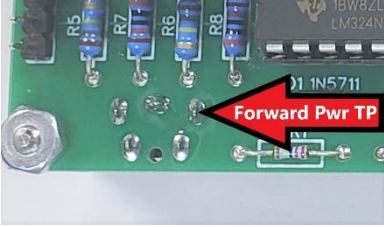
Symptom	Possible Solutions	
<p>No image on the display – MCU Board’s power LED <u>is</u> illuminated.</p>	<p>Check for:</p> <ul style="list-style-type: none"> • Check for +3.3VDC on pin 2 of header H2 on the MCU board. This voltage is used by both the MCU and TFT Display to operate. See image below for measurement location 	<p>If measurement is bad:</p> <ul style="list-style-type: none"> • Possible faulty 3.3V voltage regulator on the MCU board. • Possible short grounding the 3.3V power circuit.
		
	<ul style="list-style-type: none"> • Check for 3.3VDC on pin 1 and +5VDC on pin 8 of the TFT Display Interface Board. 	<ul style="list-style-type: none"> • Possible bad ribbon cable, or solder joint on the interface board.
	<ul style="list-style-type: none"> • Check for two illuminated green LED on the top edge of the SWR meter’s main circuit board. 	<ul style="list-style-type: none"> • If the 3.3VDC checks made above both passed, then this is a good indicator that the MCU is not operating and the board may need replacing.
	<ul style="list-style-type: none"> • All above checks proved good 	<ul style="list-style-type: none"> • The TFT Display module is possibly bad and may need replacing.
<p>Touch screen functions do not work.</p>	<p>Check for: If measurement is bad:</p>	
	<ul style="list-style-type: none"> • Check for bad solder connections on pins 10, 11, 12, or 13 of either the 14-conductor IDC header or the 14-pin female pin header on the TFT display interface board. • Also check for bad solder connections on the 14 pin IDC header on the SWR meter’s main circuit board (CN2) 	<ul style="list-style-type: none"> • Resolder any suspect solder connections.
	<ul style="list-style-type: none"> • Check for continuity between both ends of the 14-conductor ribbon cable for pins 10, 11, 12, and 13. 	<ul style="list-style-type: none"> • Possible bad ribbon cable
	<ul style="list-style-type: none"> • All above checks proved good 	<ul style="list-style-type: none"> • The TFT display’s touch screen or driver chip is possible bad and may need replacing

<p>No forward power readings <u>on any forward power meter scales</u> when transmitting.</p>	<p>Check for:</p> <ul style="list-style-type: none"> Remove the cover from the sensor assembly and connect the positive multimeter lead to the 3.5mm stereo jack's forward power solder lug and the negative lead to the chassis. <p>Set your transmitter to transmit approximately 20 Watts – the multimeter should be reading about +2 VDC.</p> <p>Note: this voltage will vary with power output.</p> <p>Refer to the image below for this test point</p>	<p>If measurement is bad:</p> <ul style="list-style-type: none"> Possibly bad solder joint for the toroid lead connected to the Fwd hole – make sure the enamel has been removed from the #26 wire before soldering. Possible bad solder joint on components D1, R2, or the wire coming from SP4. Possible bad D1
		
<ul style="list-style-type: none"> With the transmitter set to the same power output, check for +2 VDC at the forward Power test point (TP) on the lower left corner of the SWR meter's main circuit board. Refer to the image below. 		
		
<ul style="list-style-type: none"> With the transmitter set to the same power output and the meter's forward power scale set to 200 Watts full scale, Check for approximately +1.2 VDC on pin 8 of the Operational Amplifier IC (U3). Refer to the image below for guidance on this test point. <p>Note: this voltage will vary widely depending on the value of trimmer resistor R15. If you don't read anywhere near the +1.2 VDC, try adjusting R15 and note if the voltage</p>		

Symptom	Possible Solutions	
	<p>reading changes in step with the adjustment – if so, this is good.</p>  <ul style="list-style-type: none"> <li data-bbox="500 611 854 638">• All above checks prove good <li data-bbox="1013 611 1382 701">• Possible bad Analog to Digital Converter module which may need replacing. 	
<p>No reflected power readings <u>on any reflected power meter scales</u> when the sensor has been reversed.</p> <p>(Transmitter coax connected to Output connector and dummy load connected to the Input connector)</p>	<p>Check for:</p> <ul style="list-style-type: none"> <li data-bbox="500 816 987 972">• Remove the cover from the sensor assembly and connect the positive multimeter lead to the 3.5mm stereo jack's reflected power solder lug and the negative lead to the chassis. <p>Set your transmitter to transmit approximately 20 Watts – the multimeter should be reading about +2 VDC.</p> <p>Note: this voltage will vary with power output.</p> <ul style="list-style-type: none"> <li data-bbox="500 1220 954 1276">• Refer to the image below for this test point 	<p>If measurement is bad:</p> <ul style="list-style-type: none"> <li data-bbox="1013 816 1425 972">• Possibly bad solder joint for the toroid lead connected to the Refl hole – make sure the enamel has been removed from the #26 wire before soldering. <li data-bbox="1013 995 1409 1085">• Possible bad solder joint on components D2, R3, or the wire coming from SP3. <li data-bbox="1013 1108 1235 1136">• Possible bad D2
	 <ul style="list-style-type: none"> <li data-bbox="500 1556 967 1738">• With the transmitter set to the same power output, check for +2 VDC at the reflected Power test point (TP) on the lower left corner of the SWR meter's main circuit board. Refer to the image below. <li data-bbox="1013 1556 1425 1646">• Possible bad connection at either end of the stereo cable, or bad cable. 	

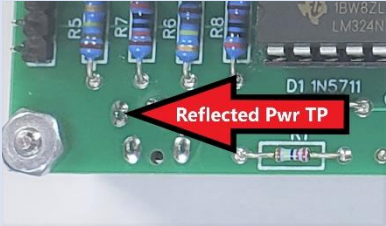
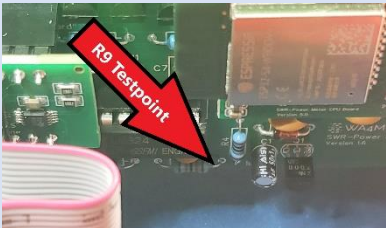
Symptom	Possible Solutions	
	<div style="text-align: center;">  </div> <ul style="list-style-type: none"> • With the transmitter set to the same power output and the meter's reflected power scale set to 200 Watts full scale, Check for approximately +1.2 VDC on the right-most lead of R9. Refer to the image below for guidance on this test point. • Note: this voltage will vary widely depending on the value of trimmer resistor R12. If you don't read anywhere near the +1.2 VDC, try adjusting R12 and note if the voltage reading changes in step with the adjustment – if so, this is good. <ul style="list-style-type: none"> • Possible bad solder joints on R6, R8, or U3 Socket. • Possible bad LM324N Quad OpAmp (U3) and may need replacing. • Possible bad (shorted) Zener diode D3. <div style="text-align: center;">  </div> <ul style="list-style-type: none"> • All above checks prove good • Possible bad Analog to Digital Converter module which may need replacing. 	
<p>No forward power readings <u>on one or two forward power meter scales</u> when transmitting.</p>	<p>Check for:</p> <ul style="list-style-type: none"> • Check for 3.3 VDC on the appropriate MCU board pin based on the faulty scale. Refer to the image below for pin locations. 	<p>If measurement is bad:</p> <ul style="list-style-type: none"> • Possible bad MCU board which may need replaced.

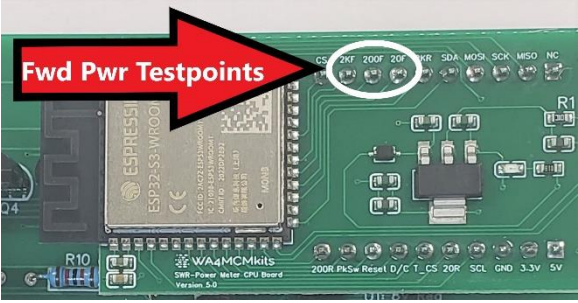
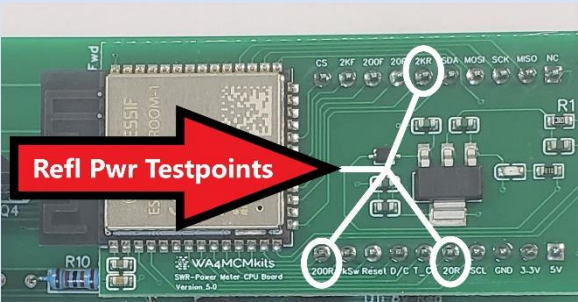
Symptom	Possible Solutions																
	<div style="text-align: center;">  <p>Fwd Pwr Testpoints</p> </div> <ul style="list-style-type: none"> Check for the appropriate green LED being illuminated depending on the chart below: <table border="1" data-bbox="548 709 852 840"> <thead> <tr> <th>Fwd Power Scale</th> <th>LED #</th> </tr> </thead> <tbody> <tr> <td>20 Watts</td> <td>LED 6</td> </tr> <tr> <td>200 Watts</td> <td>LED 5</td> </tr> <tr> <td>2000 Watts</td> <td>LED 4</td> </tr> </tbody> </table> <p>Note: the LEDs are numbered from #1 on the far left to #6 on the far right.</p> Possible bad 2N7000 N-channel MOSFET associated with the specific meter scale: <table border="1" data-bbox="1060 709 1409 840"> <thead> <tr> <th>Fwd Power Scale</th> <th>2N7000 #</th> </tr> </thead> <tbody> <tr> <td>20 Watts</td> <td>Q8</td> </tr> <tr> <td>200 Watts</td> <td>Q7</td> </tr> <tr> <td>2000 Watts</td> <td>Q6</td> </tr> </tbody> </table> <p>Note: These MOSFETs are located underneath the MCU board.</p> 	Fwd Power Scale	LED #	20 Watts	LED 6	200 Watts	LED 5	2000 Watts	LED 4	Fwd Power Scale	2N7000 #	20 Watts	Q8	200 Watts	Q7	2000 Watts	Q6
Fwd Power Scale	LED #																
20 Watts	LED 6																
200 Watts	LED 5																
2000 Watts	LED 4																
Fwd Power Scale	2N7000 #																
20 Watts	Q8																
200 Watts	Q7																
2000 Watts	Q6																
<p>No reflected power readings on one or two reflected power meter scales when the sensor has been reversed.</p> <p>(Transmitter coax connected to Output connector and dummy load connected to the input connector)</p>	<div style="text-align: center;">  <p>Refl Pwr Testpoints</p> </div> <p>Check for:</p> <ul style="list-style-type: none"> Check for 3.3 VDC on the appropriate MCU board pin based on the faulty scale. Refer to the image below for pin locations. <p>If measurement is bad:</p> <ul style="list-style-type: none"> Possible bad MCU board which may need replaced. <ul style="list-style-type: none"> Check for the appropriate green LED being illuminated depending on the chart below: <table border="1" data-bbox="548 1633 852 1764"> <thead> <tr> <th>Refl Power Scale</th> <th>LED #</th> </tr> </thead> <tbody> <tr> <td>20 Watts</td> <td>LED 3</td> </tr> <tr> <td>200 Watts</td> <td>LED 2</td> </tr> <tr> <td>2000 Watts</td> <td>LED 1</td> </tr> </tbody> </table> <p>Note: the LEDs are numbered from #1 on the far left to #6 on the far right.</p> Possible bad 2N7000 N-channel MOSFET associated with the specific meter scale: <table border="1" data-bbox="1060 1633 1409 1764"> <thead> <tr> <th>Refl Power Scale</th> <th>2N7000 #</th> </tr> </thead> <tbody> <tr> <td>20 Watts</td> <td>Q5</td> </tr> <tr> <td>200 Watts</td> <td>Q4</td> </tr> <tr> <td>2000 Watts</td> <td>Q3</td> </tr> </tbody> </table> 	Refl Power Scale	LED #	20 Watts	LED 3	200 Watts	LED 2	2000 Watts	LED 1	Refl Power Scale	2N7000 #	20 Watts	Q5	200 Watts	Q4	2000 Watts	Q3
Refl Power Scale	LED #																
20 Watts	LED 3																
200 Watts	LED 2																
2000 Watts	LED 1																
Refl Power Scale	2N7000 #																
20 Watts	Q5																
200 Watts	Q4																
2000 Watts	Q3																

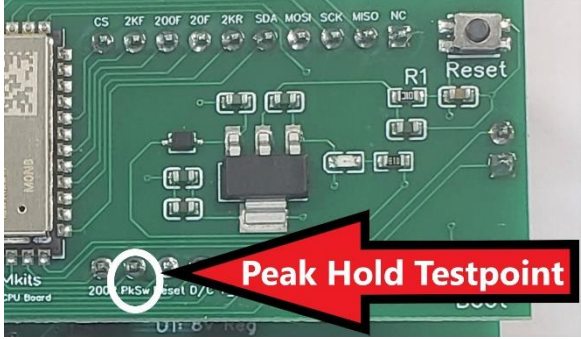
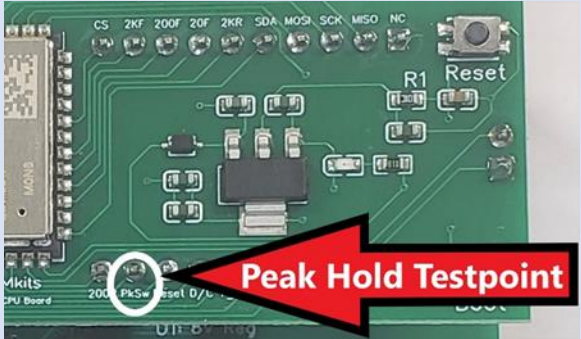
Symptom	Possible Solutions	
<p>Peak hold function does not operate for the forward power meters (bar and needle) as described.</p>	<p>Check for:</p> <ul style="list-style-type: none"> • Check for 3.3 VDC on the PkSw pin on the MCU Board. Refer to the image below for guidance. 	<p>If measurement is bad:</p> <ul style="list-style-type: none"> • Possible bad MCU board which may need replacing.
		
	<ul style="list-style-type: none"> • The above check proves good. 	<ul style="list-style-type: none"> • Possible faulty Q2 (2N7000 N-channel MOSFET).
<p>Peak hold function does not operate for the reflected power meters (bar and needle) as described.</p>	<p>Check for:</p> <ul style="list-style-type: none"> • Check for 3.3 VDC on the PkSw pin on the MCU Board. Refer to the image below for guidance. 	<p>If measurement is bad:</p> <ul style="list-style-type: none"> • Possible bad MCU board which may need replacing.
		
	<ul style="list-style-type: none"> • The above check proves good. 	<ul style="list-style-type: none"> • Possible faulty Q1 (2N7000 N-channel MOSFET).

Symptom	Possible Solutions	
<p>SWR Balance Adjustment procedure does not achieve a null close to zero watts.</p>	<p>Check for:</p> <ul style="list-style-type: none"> • Check for shorted windings on the toroid • Check for good solder connections – especially with the toroid leads as well as those of capacitor C12. Make sure that the #26 enameled wire’s enamel has been stripped where solder joints are. • All above checks prove good. 	<p>If measurement is bad:</p> <ul style="list-style-type: none"> • Rewind toroid with new #26 enameled wire. • Resolder any suspect connections. • Possible faulty trimmer capacitor C14 which may need to be replaced.
<p>VSWR accuracy is significantly off.</p>	<p>Check for:</p> <ul style="list-style-type: none"> • Accurate null achieved during <i>the SWR Balance Adjustment</i> section. <p>If measurement is bad:</p> <ul style="list-style-type: none"> • Rerun the <i>SWR Balance Adjustment</i> procedure. • Once complete, you must also rerun the entire <i>Power Scale Calibration</i> procedure. 	

SCHEMATIC DIAGRAMS

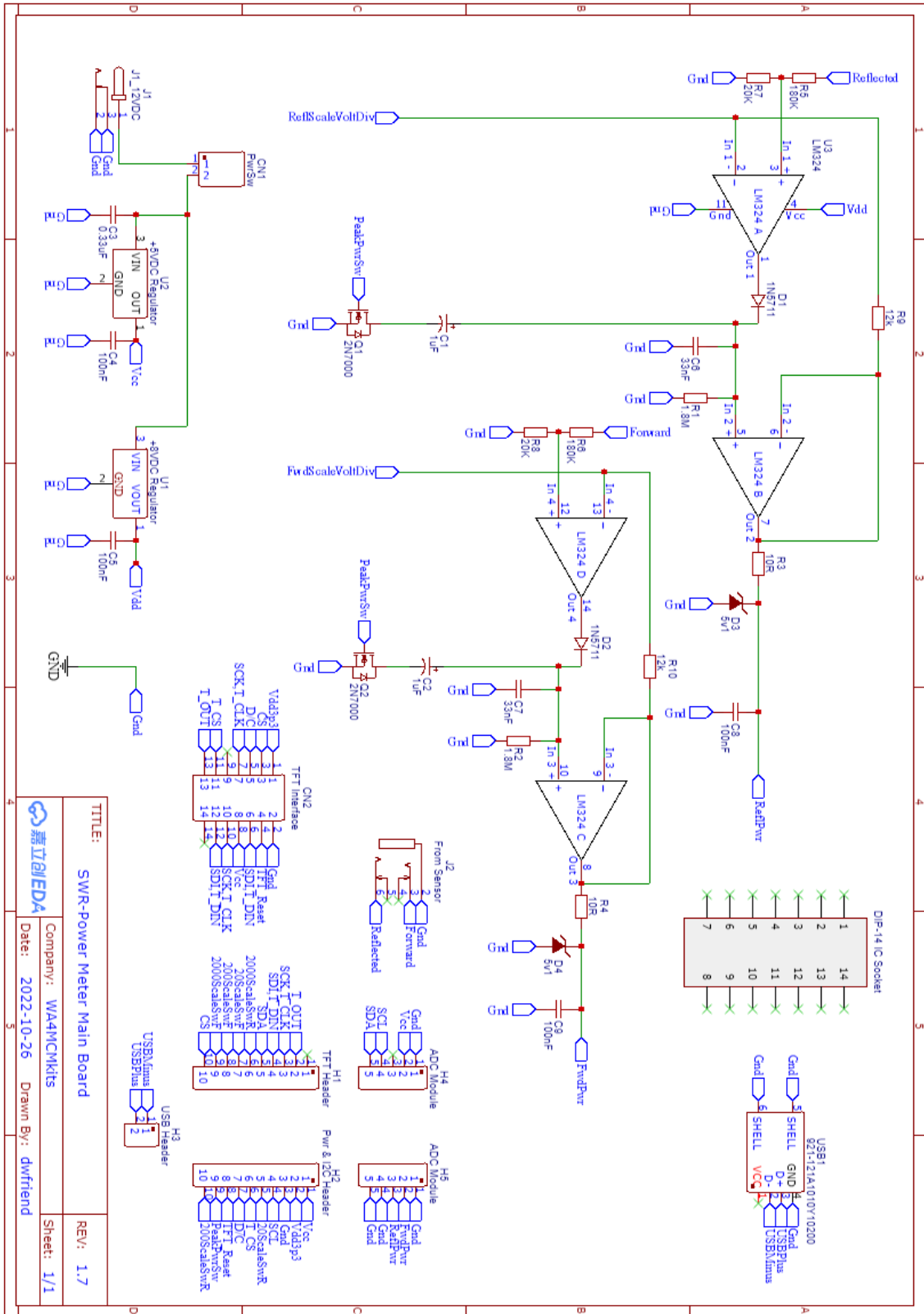

TITLE: SWR-Power Meter Main Board
 Company: WA4MCMkits
 Date: 2022-10-26
 Drawn By: dwfriend
 REV: 1.7
 Sheet: 1/1

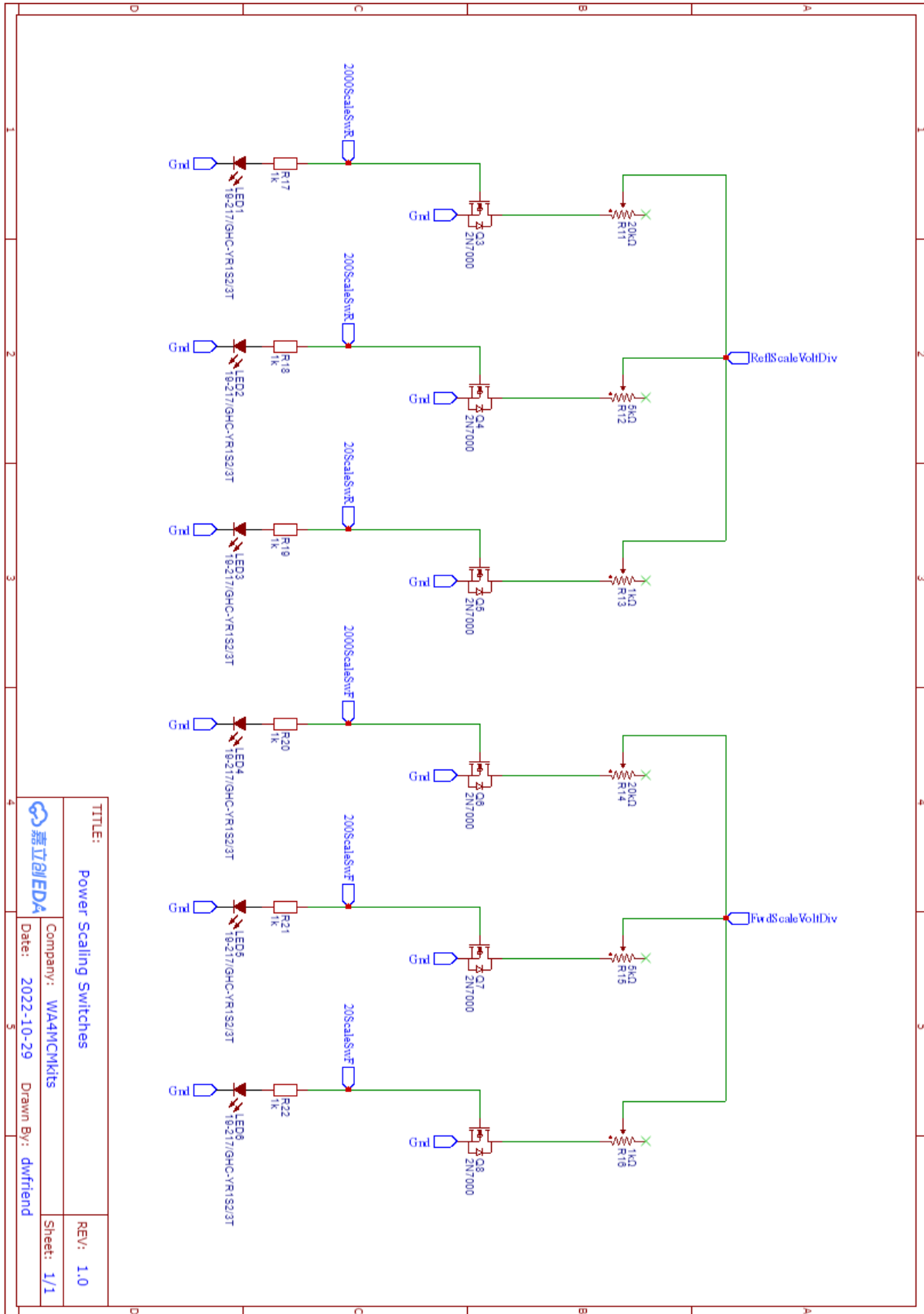

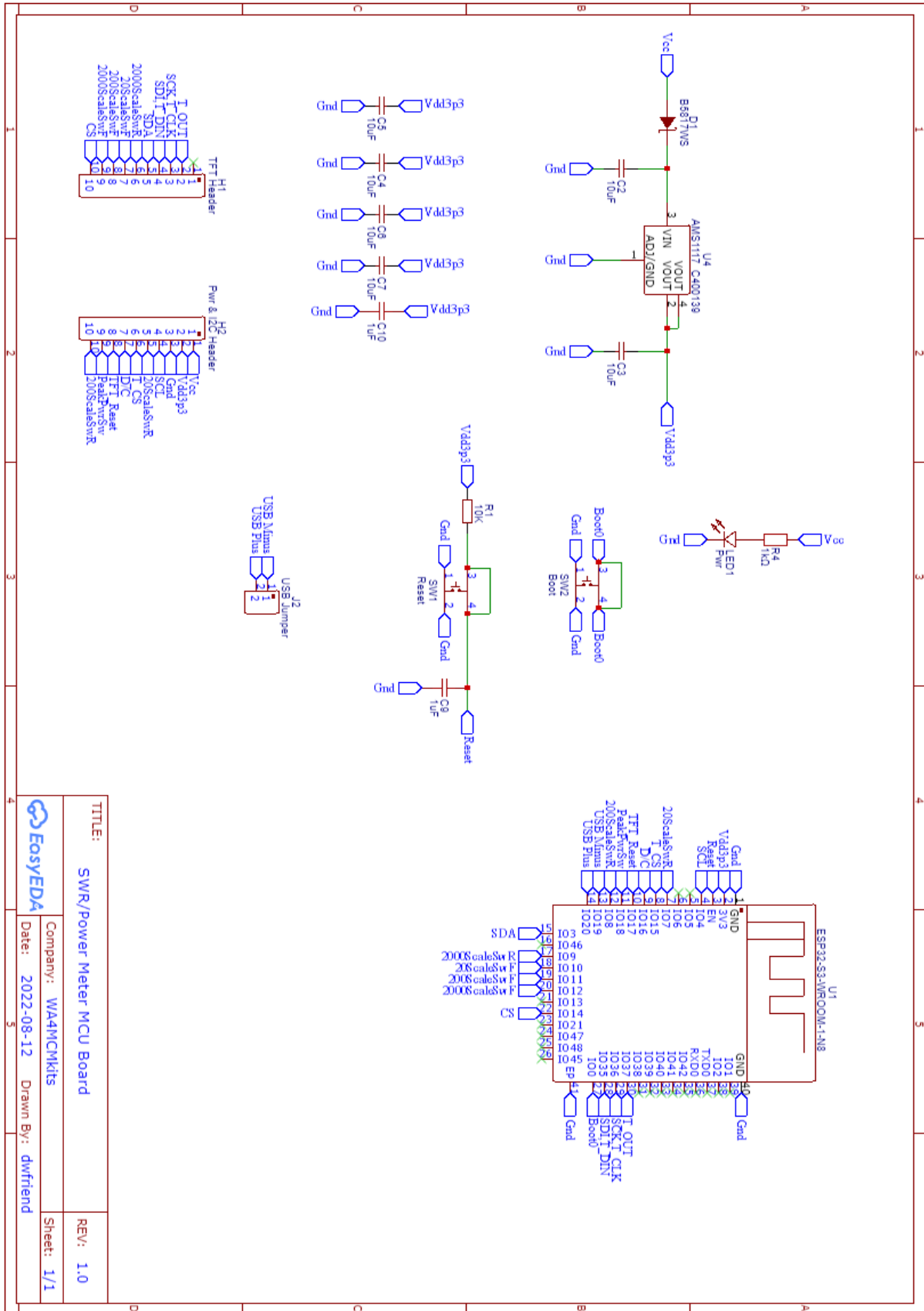

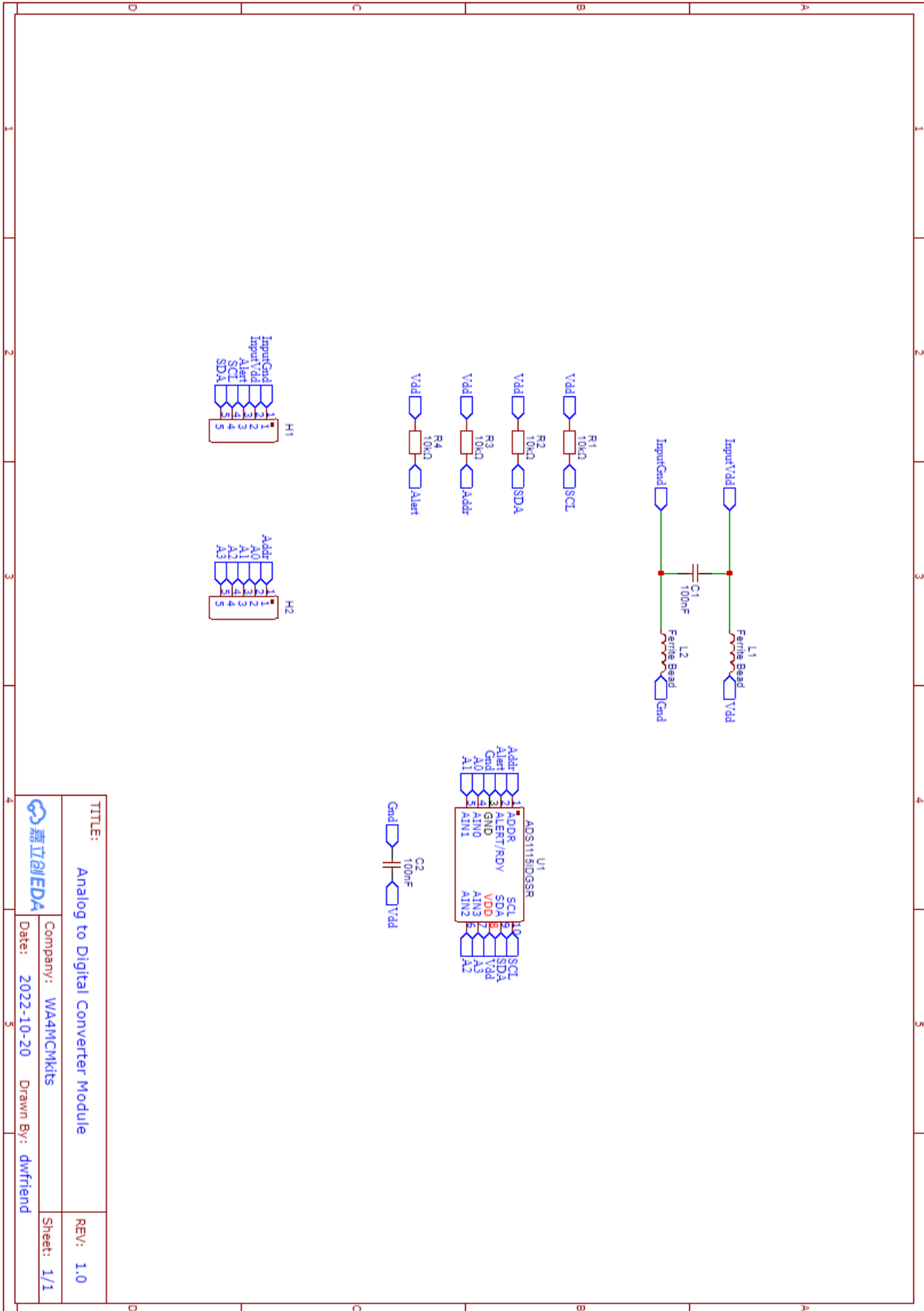

TITLE: Analog to Digital Converter Module		REV: 1.0
Company: WA4MCMkits		Sheet: 1/1
Date: 2022-10-20	Drawn By: dwfriend	