

ASSEMBLY MANUAL PSR-100 Portable Satellite Antenna Rotor Kit

Revision History

Revision Number	Date	Description	Notes
1.0	4/24/2025	<ul style="list-style-type: none">Initial Publishing of the PSR-100 assembly manual	Prior to beta testing
1.1	5/3/2025	<ul style="list-style-type: none">Fixed the quantity of the 100nf Ceramic Disk Capacitors – 6 required rather than 4.Removed erroneous 1.8M resistors from previous step 4. Artifact from SWR assembly manual.Reformatted the Wire Harnesses, Switches and Az Motor Preparation section so that it starts on a new page.Changed the quantities for the 45 tooth hub-mounted gear, 30 tooth pinion gear, and D-bore Single Sonic Hub due to the elevation shaft gear size change.Modified all steps related to the elevation shaft gear installation due to the replacement of the 45 tooth hub-mounted gear with the 30 tooth pinion gear.Fixed numerous grammatical and spelling errors.Added additional words to several steps to increase clarity.Added alternate resistor photos and band colors for 220kΩ and 1MΩ resistors.	Mods due to beta test feedback Thanks to Ron – W4DNQ and Rick – KB8NEV
1.2	7/17/2025	<ul style="list-style-type: none">Added a link to a soldering demo video published on the WA4MCMkits YouTube channel.Added a section with unpopulated circuit board images.	
1.3	7/24/2025	<ul style="list-style-type: none">Added note in step 44 to make sure that the SPST (“Flip”) switch is in the Off position before plugging it into its socket.Added a warning to step 34 about the applying too much heat when soldering the cable wires to the solder lugs.	
1.4	9/23/2025	<ul style="list-style-type: none">Changed the part description for the 30 tooth pinion gear due to supply chain changes. The new gear is now a D-bore gear -vs- a straight bore.Modified the Electronic Components Post-Assembly Testing and Final Assembly sections to accommodate the firmware change where the manual AZ and EL movement switches are now disabled unless the rotor is in calibrate mode.	

		<ul style="list-style-type: none"> Updated the Main board Headers schematic to reflect the added RF filtering. 	
1.5	1/3/2026	<ul style="list-style-type: none"> Added clarifying text to step 61 regarding the proper alignment of the brass threaded insert prior to insertion (insert from the inside of the main body layer one). Updated parts list to accommodate recent changes to gearing as well as an updated main circuit board. Updated the schematic drawings and x-ray view for the main circuit board to accommodate the addition of the low pass filter components to the MCU data lines. 	
1.6	3/2/2026	<ul style="list-style-type: none"> Modified all references to the old way of mounting the main circuit board in the main body layer one. 	
1.7	4/12/2026	<ul style="list-style-type: none"> Added pictures of the new 30 tooth and 45 tooth gears to the parts listing. 	
		<ul style="list-style-type: none"> 	
		<ul style="list-style-type: none"> 	
		<ul style="list-style-type: none"> 	
		<ul style="list-style-type: none"> 	

CONTENTS

Getting Started1

 Required Tools and supplies1

 Recommended Tools1

 Parts Inventory2

 Tips for Successful Soldering9

Electronic Components Assembly11

 PSR-100 Main Circuit Board11

 Wire Harnesses, Switches and Az Motor Preparation18

 PSR-100 WiFi Access Point Assembly21

 Electronic Components Post-Assembly Testing22

Mechanical Components Pre-assembly28

 Main Body Layer One28

 Main Body Layer Two31

 Main Body Layer Three33

 Elevation Motor Mounting Bracket34

Final Assembly40

Calibration and Testing50

 Elevation Potentiometer50

 Azimuth Potentiometer51

 Live Testing53

Troubleshooting55

Circuit Board Images66

 Main Board, MCU Module, and Analog to Digital Converter Module:66

 WiFi Access Point Module Board:67

Schematic Diagrams68

GETTING STARTED

These instructions are specifically structured to guide you through the steps required to easily complete the assembly of the portable satellite antenna rotor. The order of the sections and steps has been chosen to reduce any instances where awkward soldering or physical assembly would be needed. For instance, resistors are installed early in the main board assembly since they sit very close to the circuit board and have less chance of interfering with component placement while installing any later components such as the transistors and voltage regulators.

There are no “hard” soldering tasks on this kit. Anyone with beginner-level or better soldering skills should be able to successfully complete that portion of the assembly.

REQUIRED TOOLS AND SUPPLIES

The following tools and supplies are required to complete the assembly of the remote antenna switch:

- Soldering Iron – At least 60 watts with a thin tip is recommended. A temperature-controlled soldering station would be preferred.
- Heat gun or high temperature hair dryer – for use in shrinking heat shrink tubing.
- Rosin core solder – please see the soldering tips section below for a discussion on choosing between leaded or non-leaded solder compositions.
- Super glue
- Fine point black Sharpie permanent Marker (or similar brand)
- Allen wrenches in the following sizes: 3/32”, 3mm, 2.5mm
- 7/16” Nut Driver
- #1 and #2 phillips-head screwdrivers
- Small needle-nosed pliers
- Small diagonal wire cutters
- Small flush cutter pliers
- Wire strippers



Figure 1 - Required Tools

RECOMMENDED TOOLS







The following tools are recommended to make the assembly process easier and more precise, but are not required:



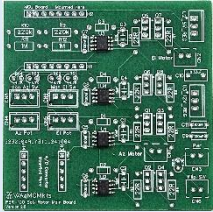

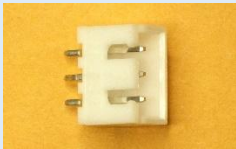



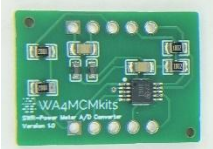

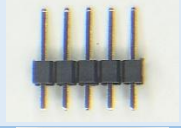
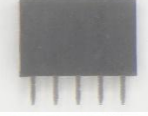
- “Helping Hands” station equipped with a magnifying glass.

PARTS INVENTORY

After unpacking all kit components and hardware, please refer to the following tables to ensure everything has been included and identified before moving to the actual assembly sections of this manual. If anything is missing, please contact the seller for replacements.

Table 1 –Main Circuit Board Parts

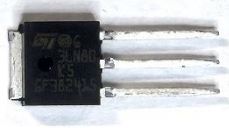
<input checked="" type="checkbox"/>	Component	Qty	Circuit Designator(s)	Identifying Marks	Image
<input type="checkbox"/>	Circuit Board – Meter Main Board	1	N/A	Version 2.8	
<input type="checkbox"/>	2 Conductor JST XH PCB Header	4	CN1, CN2, CN3, CN6	N/A	
<input type="checkbox"/>	3 Conductor JST XH PCB Header	4	CN4, CN5, CN8, CN9	N/A	
<input type="checkbox"/>	10 nf 50V Ceramic Disk Capacitor	4	C1, C2, C3, C4	103	
<input type="checkbox"/>	100 nf 50 V Ceramic Disk Capacitor	6	C5, C6, C7, C8, C9, C11	104	
<input type="checkbox"/>	330 nf Ceramic Disk Capacitor	1	C10	334 (this may vary)	
<input type="checkbox"/>	1N4148 Small Signal Diode	4	D1, D2, D3, D4	1N4148	
<input type="checkbox"/>	Analog-to-digital Converter (ADC) Module	1	N/A	Version 1.0	

<input checked="" type="checkbox"/>	Component	Qty	Circuit Designator(s)	Identifying Marks	Image
<input type="checkbox"/>	5-pin male pin header	2	H3, H4	N/A	
<input type="checkbox"/>	5-pin female header	2	H3, H4	N/A	
<input type="checkbox"/>	PSR-100 Microcontroller Module	1	N/A	Version 2.2	
<input type="checkbox"/>	8-pin male pin header	2	H1, H2	N/A	
<input type="checkbox"/>	8-pin female header	2	H1, H2	N/A	
<input type="checkbox"/>	22Ω ¼ W Resistor	8	R1, R2, R3, R4, R5, R6, R7, R8	red / red/ black / gold	
<input type="checkbox"/>	4.7kΩ ¼ W Resistor	5	R13, R14, R15, R16, R17	yellow / violet / red / gold	
<input type="checkbox"/>	220kΩ ¼ W Resistor	2	R9, R10	red / red/ yellow / gold -or- Red / red/ black / orange / brown	
<input type="checkbox"/>	1MΩ ¼ W Resistor	2	R11, R12	brown / black / green / gold -or- Brown / black / black / yellow / brown	
<input type="checkbox"/>	N-Channel Power MOSFET	8	Q1, Q2, Q3, Q4, Q5, Q6, Q7, Q8		
<input type="checkbox"/>	LM7805 5V Linear Voltage Regulator	1	U2_5V_REG	LM7805	
<input type="checkbox"/>	TO-220 Heat Sink	1	U2_5V_REG	N/A	









<input checked="" type="checkbox"/>	Component	Qty	Circuit Designator(s)	Identifying Marks	Image
<input type="checkbox"/>	LM7812 12V Linear Voltage Regulator	1	U3_12V_REG	UTC LM7812L	

Table 2 – Main Body Parts

<input checked="" type="checkbox"/>	Component	Qty	Circuit Designator(s)	Identifying Marks	Image
<input type="checkbox"/>	Main Body Layer One	1	N/A	N/A	
<input type="checkbox"/>	Main Body Layer Two	1	N/A	N/A	
<input type="checkbox"/>	Main Body Layer Three	1	N/A	N/A	
<input type="checkbox"/>	Main Body Top Plate	1	N/A	N/A	
<input type="checkbox"/>	Elevation Motor Mounting Bracket	1	N/A	N/A	
<input type="checkbox"/>	Lower Antenna Mounting Arm	1	N/A	N/A	
<input type="checkbox"/>	Upper Antenna Mounting Arm	1	N/A	N/A	

<input checked="" type="checkbox"/>	Component	Qty	Circuit Designator(s)	Identifying Marks	Image
<input type="checkbox"/>	12VDC 2rpm Motor	2	N/A	JGY-370	
<input type="checkbox"/>	10kΩ Linear Taper Potentiometer	2	N/A	B10K Alpha	
<input type="checkbox"/>	DC Power Receptacle – Panel Mount	1	N/A	N/A	
<input type="checkbox"/>	SPST Toggle Switch	1	N/A	The switch's color may vary	
<input type="checkbox"/>	SPDT Momentary on/off/on Toggle Switch	2	N/A	N/A	
<input type="checkbox"/>	2 conductor cable assembly - 120mm long	4	N/A	N/A	
<input type="checkbox"/>	3 conductor cable assembly - 120mm long	4	N/A	N/A	
<input type="checkbox"/>	1/8" Heat Shrink Tubing – 6 inches long	1	N/A	N/A	
<input type="checkbox"/>	1/4-20 Brass Threaded Insert	1	N/A	N/A	
<input type="checkbox"/>	12" 24AWG Stranded Hookup wire - Yellow	1	N/A	N/A	

☑	Component	Qty	Circuit Designator(s)	Identifying Marks	Image
<input type="checkbox"/>	24" 24AWG Stranded Hookup wire - Red	1	N/A	N/A	
<input type="checkbox"/>	24" 24AWG Stranded Hookup wire - Black	1	N/A	N/A	
<input type="checkbox"/>	6mm I.D. x 14mm O.D Ball Bearing	2	N/A	N/A	
<input type="checkbox"/>	6mm to 6mm set-screw shaft coupler	1	N/A	N/A	
<input type="checkbox"/>	30 Tooth, 6mm D-Bore Pinion Gear	2	N/A	This part may vary in color as well as bore shape	 <p data-bbox="1268 1171 1310 1199">-or-</p>  <p data-bbox="1268 1398 1310 1425">-or-</p> 

<input checked="" type="checkbox"/>	Component	Qty	Circuit Designator(s)	Identifying Marks	Image
<input type="checkbox"/>	45 Tooth Hub-mount Gear	1	N/A	This part may vary in color	 <p>-or-</p> 
<input type="checkbox"/>	15 Tooth 1/4" Bore Pinion Gear	1	N/A	N/A	
<input type="checkbox"/>	1/4" Bore Set-screw Hub	1	N/A	N/A	
<input type="checkbox"/>	6mm D-bore Double Sonic Hub	1	N/A	N/A	
<input type="checkbox"/>	6mm D-bore Single Sonic Hub	1	N/A	N/A	
<input type="checkbox"/>	6mm x 60mm D Shaft	2	N/A	N/A	









<input checked="" type="checkbox"/>	Component	Qty	Circuit Designator(s)	Identifying Marks	Image
<input type="checkbox"/>	3" Square Ball Bearing Turntable	1	N/A	N/A	
<input type="checkbox"/>	6-32 x 1/4" pan head machine screw	14	N/A	N/A	
<input type="checkbox"/>	M3 x 6mm Pan Head Screw	8	N/A	N/A	
<input type="checkbox"/>	M4 x 10mm Pan Head Screw	6	N/A	N/A	
<input type="checkbox"/>	M4 x 20mm Pan Head Screw	3	N/A	N/A	
<input type="checkbox"/>	M4 x 30mm Pan Head Screw	2	N/A	N/A	

Table 3 - WiFi Access Point Parts

<input checked="" type="checkbox"/>	Component	Qty	Circuit Designator(s)	Identifying Marks	Image
<input type="checkbox"/>	WiFi Access Point Module	1	N/A	N/A	
<input type="checkbox"/>	WiFi Access Point Enclosure Bottom	1	N/A	N/A	
<input type="checkbox"/>	WiFi Access Point Enclosure Top	1	N/A	N/A	

TIPS FOR SUCCESSFUL SOLDERING

This kit has been designed to ensure relatively easy soldering. Also, the components have been placed on the circuit boards with plenty of spacing. Finally, we have chosen to use all through hole rather than surface mount components to accommodate beginning kit builders.

If this is your first attempt at building an electronics kit, or it has been a while since you've wielded a soldering iron, please refer to the following soldering tips:

1. Wear safety glasses! Consider using a small fan to blow the soldering fumes away from your nose.
2. Use a good soldering iron, or a temperature-controlled soldering station. A soldering station is preferred since it would likely come with a tip cleaning station. See *Figure 2 - Soldering Station Example* for a common example of an inexpensive soldering station. Decent soldering stations will cost about \$20 to \$30.
3. Consider using a "helping hands" station. Some versions of these also include a magnifying glass which will come in handy with some of the smaller components. Refer to *Figure 3 - "Helping Hands" Example* for an example.
4. Use the thinnest solder appropriate for the project – a diameter of around .032 works well for the type of circuit board soldering encountered on this kit.
5. 63/37 (Tin/Lead) solder is recommended for beginners since the lead content lowers the melting point of the solder which allows for much easier soldering. However, lead can be harmful to humans, so there are non-lead solders available. These non-lead types of solder have their drawbacks – the most prevalent being the high melting temperature. In the end, it is up to the individual to decide which type of solder to use.
6. Allow the soldering iron to reach its working temperature before trying to solder any components. A good working temperature for the types of components used in this kit is between 325° C and 375° C. This will also depend on the type of solder being used – please refer to the solder manufacturer's recommendations for the optimum temperature.
7. Tin the soldering iron by applying a small amount of solder directly on the iron's tip prior to touching the iron to the circuit board and component being soldered. The reason for this is that a tinned tip will transfer heat much faster, thus reducing the amount of time needed to get the solder to flow around the component lead and circuit board pad.
8. Try to structure your soldering activities by placing several components on the circuit board before picking up the soldering iron. This allows for more efficient soldering since the iron will remain tinned throughout this soldering cycle.



Figure 2 - Soldering Station Example



Figure 3 - "Helping Hands" Example

9. Apply the tip of the soldering iron evenly to both the circuit board pad and the component lead first. Then touch the solder to the lead and allow it to spread, or “flow” as it’s known in the trade. When you see the solder flow, you will know that you have a strong, well soldered joint.
10. Don't use too much solder– “the bigger the blob, the better the job” is not true here. Some have described the perfect solder joint as looking like a small Hershey’s Kiss (or a small volcano if you don’t like chocolate).
11. Clean the tip often using brass wool, or a damp sponge. Brass wool has become the preferred material since it will not lower the temperature of the soldering tip. The constant cooling and reheating of the tip can shorten its life due to contraction and expansion. However, a damp sponge will clean the tip as well.
12. Don't move the joint while it is cooling, and don't blow on it to cool it off. This can cause a “cold” solder joint which can result in a high electrical resistance between the component and the circuit board.

For further information, please check out this informative video published on the WA4MCMkits YouTube channel: <https://youtu.be/PRYvPBZxy5o>.

ELECTRONIC COMPONENTS ASSEMBLY

The order in which components are placed on the circuit board does have a bearing on how easy it is to complete the board. The steps listed in this section have been arranged to make it as easy as possible to place and solder the component leads.

PSR-100 MAIN CIRCUIT BOARD

Note: Most of the components on this board all have wire leads. The following tips will help with the placement and soldering of these components:

- The following illustration shows how to “lock” the component in place by slightly bending the leads.

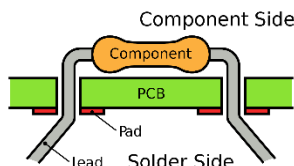

- For the resistors and diodes, use your needle nosed pliers to bend the leads on either side of the component so that they fit the holes provided for that component.
- Trim the leads using your diagonal wire cutters so they only protrude about ½ inch beyond the bottom of the circuit board.
- All components will have their component number printed as close as possible to their outline.
- Where possible, the component’s value will be printed within their outline. If there is no room within the outline, then the value will be printed as close to it as possible.

- 1 Insert each of the 8 **22 Ω ¼ watt resistors (red / red / black / gold)** at their respective locations: **R1, R2, R3, R4, R5, R6, R7 and R8**. Then solder all 16 leads. Once all leads have been soldered, cut the excess leads flush with the solder joint using your diagonal cutters.
- 2 Insert each of the 2 **220k Ω ¼ watt resistors (red / red / yellow / gold)** at their respective locations: **R9 and R10**. Then solder all 4 leads. Once all leads have been soldered, cut the excess leads flush with the solder joint using your diagonal cutters.
- 3 Insert each of the 2 **1M Ω ¼ watt resistors (brown / black / green / brown)** at their respective locations: **R11 and R12**. Then solder all 4 leads. Once all leads have been soldered, cut the excess leads flush with the solder joint using your diagonal cutters.

- 4 Insert each of the 4 **1N4148 Small Signal diodes** at their locations: **D1, D2, D3 and D4**.

Important! - Ensure that the black stripe on each diode aligns with the stripe printed on the circuit board outline as shown in the image below.

Then solder all 8 leads. Once they have been soldered, cut the excess leads flush with the solder joint using your diagonal cutters.

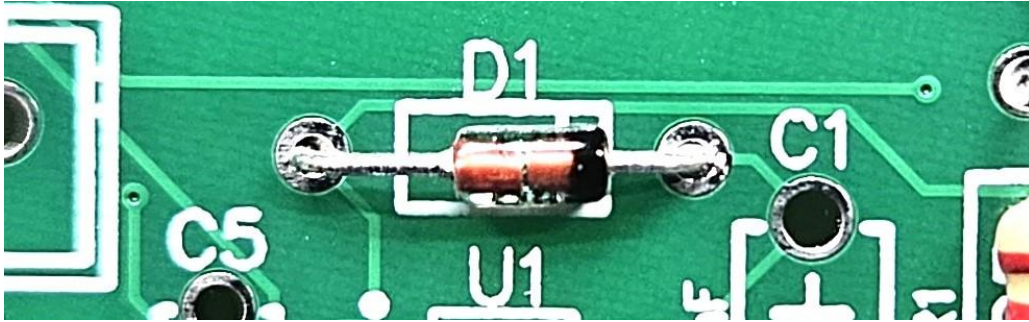

- 5 Insert one of the **2-conductor JST XH PCB Headers** in the location marked **CN1** for the **Az Motor**. Orient the header as shown in the image to the right. Solder both pins. No need to cut off the excess as these pins will not protrude far beyond the bottom of the circuit board.



- 6 Insert the second **2-conductor JST XH PCB Headers** in the location marked **CN2** for the **EI Motor**. Orient the header as shown in the image to the right. Solder both pins. No need to cut off the excess as these pins will not protrude far beyond the bottom of the circuit board.



- 7 Insert the third **2-conductor JST XH PCB Headers** in the location marked **CN3** for the **Pwr**. Orient the header as shown in the image to the right. Solder both pins. No need to cut off the excess as these pins will not protrude far beyond the bottom of the circuit board.



- 8 Insert the last **2-conductor JST XH PCB Headers** in the location marked **CN6** for the **Flip Sw**. Orient the header as shown in the image to the right. Solder both pins. No need to cut off the excess as these pins will not protrude far beyond the bottom of the circuit board.

Note: This header is oriented 180° differently than the other three 2-conductor headers.



- 9 Insert one of the **3-conductor JST XH PCB Headers** in the location marked **CN4** for the **Az Pot**. Orient the header as shown in the image to the right. Solder all three pins. No need to cut off the excess as these pins will not protrude far beyond the bottom of the circuit board.

Note: All 4 of the 3-conductor JST XH headers will be aligned in the same direction.



- 10 Repeat step 9 for the remaining 3 **3-conductor JST XH PCB Headers** in the locations marked **CN5, CN8 and CN9** for the **El Pot, Man Az Sw** and **Man El Sw**, respectively. Orient the headers as shown in the image in step 9. Solder all 9 pins. No need to cut off the excess as these pins will not protrude far beyond the bottom of the circuit board.

- 11 Prepare each the 5 **4.7k Ω 1/4 watt resistors (yellow / violet / red / gold)** by cutting and bending their leads as shown in the image to the right:

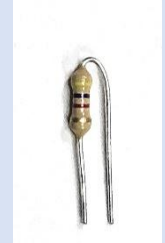

- 12 Now, Insert each of the 5 **4.7k Ω 1/4 watt resistors (yellow / violet / red / gold)** at their respective locations: **R13, R14, R15, R16 and R17**. Then solder all 10 leads. Once all leads have been soldered, cut the excess leads flush with the solder joint using your diagonal cutters.

Note: These resistors will be mounted vertically as shown in the image below:



- 13 Insert one of the 8 pin female headers at the location marked: **H1**.
- Turn the circuit board over while holding the header in place and carefully lay the board down on the work surface. Ensure that the 8 pins are still protruding through the circuit board. The weight of the board should ensure that the connector will remain in place while you solder the pins.

Solder **one of the pins** while ensuring that the connector remains flush AND perpendicular with the circuit board. Then solder the remaining 7 pins before moving to the next step.

Important Tip: It is much easier to adjust the positioning of the 8-pin header while only one of the pins has been soldered. Make sure that the header is perpendicular to the circuit board as well as aligned with the header's white outline on the surface of the circuit board before soldering the remaining 9 pins. If need be, reheat the solder connection while manipulating the header in position with your other hand.

- 14 Repeat step 13 for the other 8 pin female header at the location marked: **H2**.

- 15 Insert one of the 5 pin female headers at the location marked: **H3**.
- Turn the circuit board over while holding the header in place and carefully lay the board down on the work surface. Ensure that the 5 pins are still protruding through the circuit board. The weight of the board should ensure that the connector will remain in place while you solder the pins.

Solder **one of the pins** while ensuring that the connector remains flush AND perpendicular with the circuit board. Then solder the remaining 4 pins before moving to the next step.

Important Tip: It is much easier to adjust the positioning of the 5-pin header while only one of the pins has been soldered. Make sure that the header is perpendicular to the circuit board as well as aligned with the header's white outline on the surface of the circuit board before soldering the remaining 4 pins. If need be, reheat the solder connection while manipulating the header in position with your other hand.

- 16 Repeat step 15 for the 5 pin female header at the location marked: **H4**.



- 17 Insert each of the 4 **10 nf ceramic disk capacitors (103)** at their respective locations: **C1, C2, C3 and C4**. Then solder all 8 leads. Once all leads have been soldered, cut the excess leads flush with the solder joint using your diagonal cutters.



- 18 Insert each of the 6 **100 nf ceramic disk capacitors (104)** at their respective locations: **C5, C6, C7, C8, C9 and C11**. Then solder all 12 leads. Once all leads have been soldered, cut the excess leads flush with the solder joint using your diagonal cutters.



- 19 Insert the **330 nf ceramic disk capacitor (334)** at its location **C10**. Solder both leads. Once they have been soldered, cut the excess leads flush with the solder joint using your diagonal cutters.



- 20 Insert the 8 **N-Channel Power MOSFETs** into their respective locations at **Q1, Q2, Q3, Q4, Q5, Q6, Q7 and Q8**. Ensure that their tabs are aligned with the double lines on the circuit board as shown in the image to the right. Slightly spread the outer two leads of each MOSFET to prevent them from falling out of their locations when turning the board over. Solder all of the leads. Once all of the pins have been soldered, trim the excess leads flush with the solder joint using your diagonal cutters.

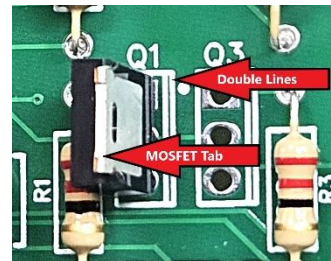

- 21 Prepare the **LM7805 5V Linear Voltage Regulator** by installing the **TO-220 Heat Sink** using the screw provided with the heat sink. Refer to the image below for guidance:

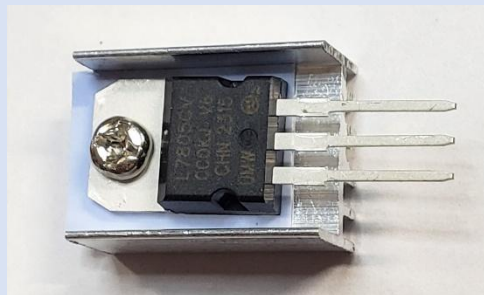

- 22 Insert the **LM7805 5V Linear Voltage Regulator** in its location: **U2_5V_REG**. The bottom of the **TO-220 heat sink** should sit directly on the circuit board.

Important! - Ensure that the "Tab" side of the voltage regulator case aligns with its outline on the circuit board as shown in the image to the right.

Then solder all 3 leads. Once all leads have been soldered, cut the excess leads flush with the solder joint using your diagonal cutters.

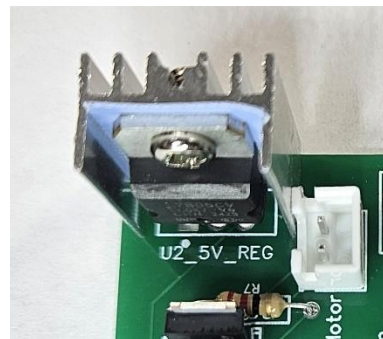

- 23 Insert the **LM7812 12V Linear Voltage Regulator** in its location: **U3_12V_REG**. The size of the circuit board holes will prevent the regulator from sitting flush with the board – this is normal.

Important! - Ensure that the "Tab" side of the voltage regulator case aligns with its outline on the circuit board as shown in the image to the right.

Then solder all 3 leads. Once all leads have been soldered, cut the excess leads flush with the solder joint using your diagonal cutters.

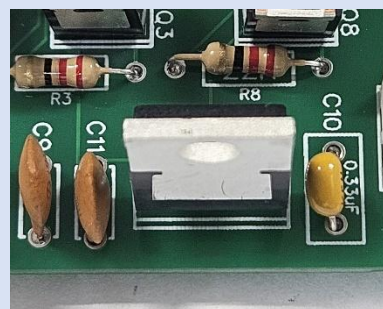

- 24 Insert the short pins of the 2 **5-pin male pin headers** into the underside of the **Analog-to-digital converter (ADC)** module as shown in the image to the right.

Turn the module over while holding the headers in place and carefully lay it down on the work surface. Ensure that the 10 pins are still protruding through the circuit board. The weight of the board should ensure that the connector will remain in place while you solder the pins.

Solder **one of the pins** on each header while ensuring that the connector remains flush AND perpendicular with the circuit board. Then solder the remaining 8 pins before moving to the next step.



Important Tip: It is much easier to adjust the positioning of each 5-pin header while only one of its pins has been soldered. Make sure each header is perpendicular to the circuit board as well as aligned with the header's white outline on the underside of the module before soldering the remaining 4 pins. If need be, reheat the solder connection while manipulating the header in position with your other hand.

- 25 Insert the short pins of the 2 **8-pin male pin headers** into the underside of the **PSR-100 Microcontroller Module** as shown in the image to the right.



Turn the module over while holding the headers in place and carefully lay it down on the work surface. Ensure that the 16 pins are still protruding through the circuit board. The weight of the board should ensure that the connector will remain in place while you solder the pins.

Solder **one of the pins** on each header while ensuring that the connector remains flush AND perpendicular with the circuit board. Then solder the remaining 14 pins before moving to the next step.

Important Tip: It is much easier to adjust the positioning of each 8-pin header while only one of its pins has been soldered. Make sure each header is perpendicular to the circuit board as well as aligned with the header's white outline on the underside of the module before soldering the remaining 4 pins. If need be, reheat the solder connection while manipulating the header in position with your other hand.

- 26 Locate the pin labeled **Pin 1** on the **Analog-to-digital converter (ADC) Module**. Orient this pin so that it corresponds to the Pin 1 label on the left end of header H3 on the main board. Gently insert the module all the way into the two headers (H3 and H4). Please refer to the image below for the proper alignment:

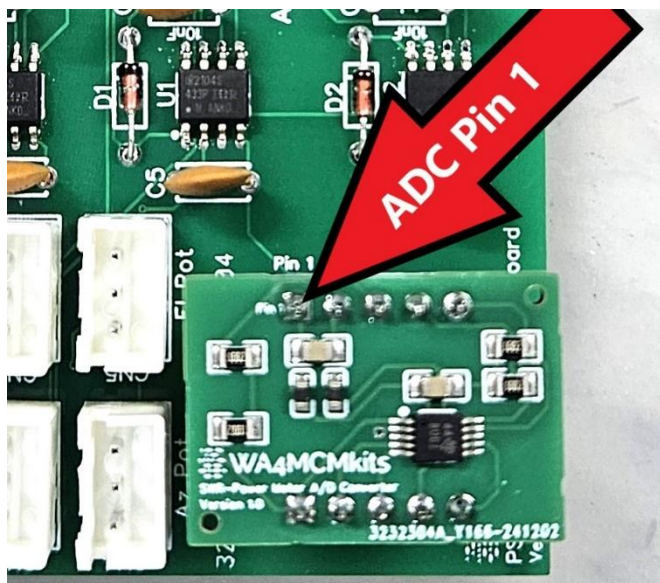

- 27 Align the pins of the two headers on the underside of the **PSR-100 Microcontroller Module** with the mating headers H1 and H2 on the main board, and then gently press the module into the main board's headers. Please refer to the image below for the proper alignment:

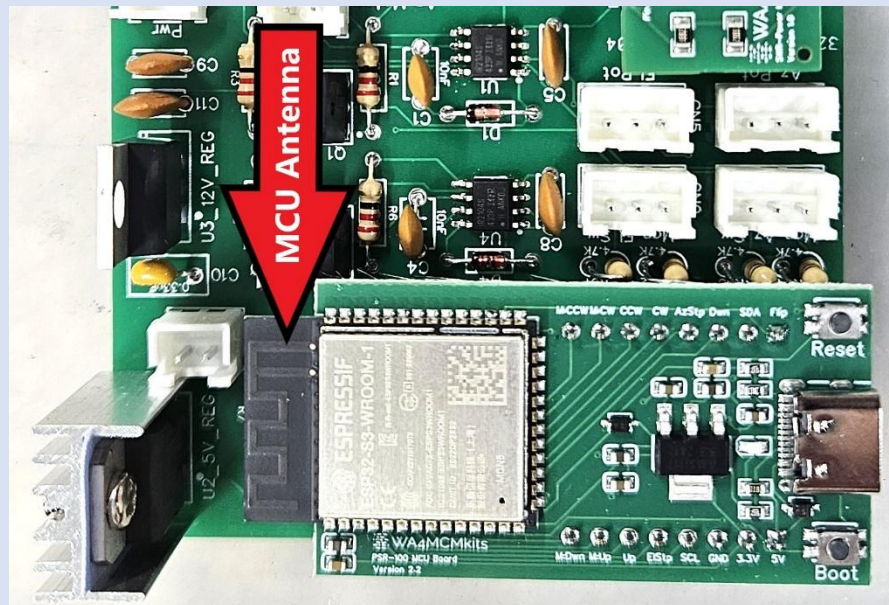

- 28 This completes the assembly of the PSR -100 Main Circuit Board. Set it aside for later when it is tested in the *Electronic Components Post-Assembly Testing* section. Please proceed to the next section: **Wire Harnesses, Switches and Az Motor Preparation.**

WIRE HARNESES, SWITCHES AND AZ MOTOR PREPARATION

This section will step you through the preparation of the various wire harnesses used to connect the motors and angle reading potentiometers to the main circuit board. The harnesses destined for the elevation components will need to be extended by soldering 12" lengths of stranded wire to the existing 2- and 3-conductor 120mm cable assemblies.

Please refer to the following guidance for joining the stranded wire to the wires of the existing cable assemblies:

Use wire strippers to remove approximately $\frac{1}{4}$ " of insulation from the ends of both wires. Twist the two wires together as shown in the image below, and the solder them:

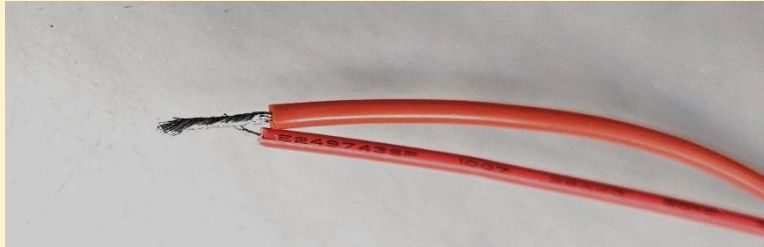

Next, bend the wires as shown in the image below and slip a $\frac{3}{4}$ " piece of $\frac{1}{8}$ " heat shrink tubing over the wires as shown.



Finally, slide the heat shrink tubing over the solder joint so that equal parts extend on either side of the joint and use a heat gun (or other heat source such as a hair drier) to shrink the tubing as shown below:



- 29 Locate one of the **2-conductor 120mm long cable assemblies** as well as the **$\frac{1}{8}$ " Heat Shrink Tubing** and the **Red and Black 24AWG Stranded Hookup wires**.

Cut (2) $\frac{3}{4}$ " long pieces of the **$\frac{1}{8}$ " Heat Shrink Tubing**.

Cut each of the **Red and Black 24AWG Stranded Hookup wires** in half (12" pieces) and set aside one piece of each color to be used in the following step.

Using the method described at the beginning of this section, extend the length of the red and black wires of the **2-conductor 120mm long cable assembly** using the appropriately colored **24AWG Stranded Hookup wires**. The final result should look like the image to the right:



Set the completed cable assembly aside – it will be used to connect the elevation motor to the main circuit board in the **Final Assembly** section.

- 30 Locate one of the **3-conductor 120mm long cable assemblies** as well as the **Yellow 24AWG Stranded Hookup wire**. You will also need the remaining two pieces of the **Red and Black 24AWG Stranded Hookup Wires** left over from the previous step.

Cut (3) $\frac{3}{4}$ " long pieces of the **$\frac{1}{8}$ " Heat Shrink Tubing**.

Using the method described at the beginning of this section, extend the length of all three wires of the **3-conductor 120mm long cable assembly** using the appropriately colored **24AWG Stranded Hookup wires**. The final result should look like the image to the right:

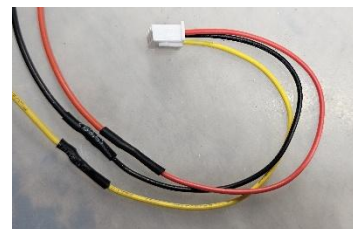

Set the completed cable assembly aside – it will be used to connect the elevation angle reading potentiometer to the main circuit board in the **Final Assembly** section.

- 31 Locate another one of the **2-conductor 120mm long cable assemblies** as well as the **Panel Mount DC Power Receptacle**.

Strip approximately $\frac{1}{4}$ " of insulation from the end of the black lead, and approximately $\frac{1}{8}$ " of insulation from the red lead. Tin the ends of both leads using your soldering iron.

Solder the red lead to the center tab of the power receptacle as shown in the image to the right. Likewise, insert the black lead through both of the ground tabs and solder both as shown in the image.

Set the completed Power Receptacle assembly aside.

It will first be used in the **Electronic Components Post-Assembly Testing** section.

Then It will be mounted on Layer One of the Main Body and connected to the main circuit board in the **Main Body Layer One** section.

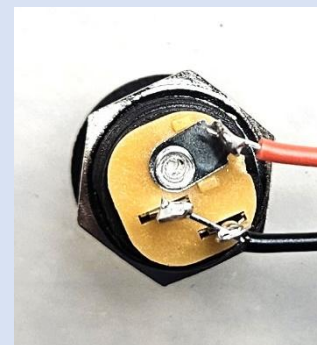

- 32 Locate another one of the **3-conductor 120mm long cable assemblies** as well as one of the **10kΩ Linear Taper Potentiometers**. This potentiometer will be used to transmit the azimuth angles to the PSR-100 Microcontroller Module.

Strip approximately $\frac{1}{8}$ " of insulation from all three leads of the cable assembly. Tin the ends of all leads using your soldering iron.

Orient the potentiometer as shown in the image to the right. Solder the red lead to the top-most tab of the potentiometer as shown in the image to the right. Likewise, solder the black lead to the center tab, and the yellow lead to the bottom-most tab.

Important! The colored wires must be connected as shown in the image, or the azimuth readings being sent to the microcontroller will be reversed.

Set the completed Azimuth Potentiometer assembly aside.

It will first be used in the **Electronic Components Post-Assembly Testing** section.

Then it will be mounted on Layer Three of the Main Body and connected to the main circuit board in the **Main Body Layer Three** section.

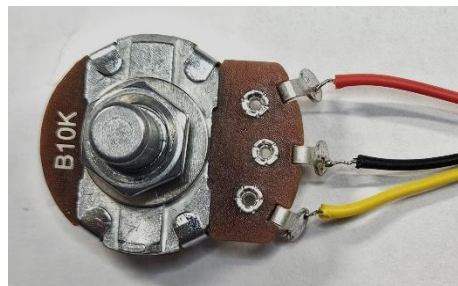

- 33 Solder both leads from one of the remaining **2-conductor 120mm long cable assemblies** to the **SPST Toggle Switch**. It doesn't matter which color wire goes to which solder lug – just solder one wire to each lug.

Set the completed Flip Switch assembly aside.

It will first be used in the **Electronic Components Post-Assembly Testing** section.

It will then be plugged into the main circuit board in the **Main Body Layer One** section.

Finally, it will be mounted on Layer Two of the Main Body in the **Final Assembly** section.

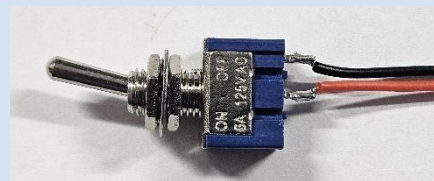

- 34 Solder all three leads from one of the remaining **3-conductor 120mm long cable assemblies** to one of the **SPDT Momentary on/off/on Toggle Switches**. Be sure to solder the black wire to the center solder lug. The red and yellow leads may be soldered to either of the remaining lugs as shown in the image to the right.

Warning! Too much heat on the solder lugs can easily damage this switch. Please use caution when soldering these leads.

Set the completed Manual Azimuth Movement Switch assembly aside.

It will first be used in the **Electronic Components Post-Assembly Testing** section.

Then it will be mounted on Layer One of the Main Body and connected to the main circuit board in the **Main Body Layer One** section.



- 35 Repeat the previous step (step 34) using the remaining **3-conductor 120mm long cable assembly** and the remaining **SPDT Momentary on/off/on Toggle Switch**.



Set the completed Manual Elevation Movement Switch assembly aside.

It will first be used in the **Electronic Components Post-Assembly Testing** section.

Then it will be mounted on Layer One of the Main Body and connected to the main circuit board in the **Main Body Layer One** section.

- 36 Cut (2) ¼" long pieces of the ⅛" **Heat Shrink Tubing**.



Slide one piece over the end of the red wire on the remaining **2-conductor 120mm long cable assembly**. Use your needle nose pliers to bend the stripped end of the wire and crimp it to the positive solder lug on one of the **12VDC 2rpm Motors**.

Repeat the above for the black wire. Refer to the image below for guidance:

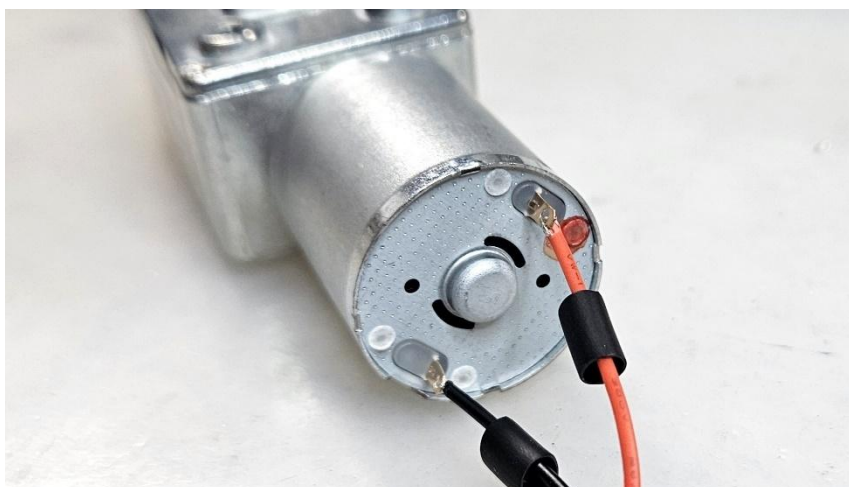

Solder both wires to the solder lugs.

Push the heat shrink tubing flush against the bottom of the motor and use a heat gun to shrink the tubing.

This is the azimuth motor. It will be installed in the **Main Body Layer Two** later on in the assembly process.

- 37 This completes the preparation of all wiring harnesses and switch assemblies. Please proceed to the next section: **PSR-100 WiFi Access Point Assembly**.



PSR-100 WIFI ACCESS POINT ASSEMBLY

This section will step through the assembly of the PSR-100's Wifi Access Point "Dongle". The access point consists of a fully assembled ESP32-S3 microcontroller module with a USB-A port designed to be installed in a laptop or PC.

- 38 Insert the **WiFi Access Point Module** into the bottom half of the **WiFi Access Point Enclosure** as shown in the image below:

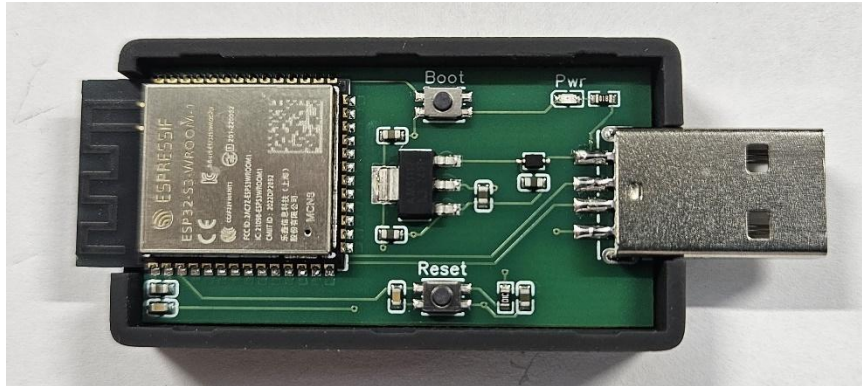

The Access Point Module will only fit into the case bottom one way, so there should be no issues.

- 39 Align the top half of the **WiFi Access Point Enclosure** such that the end tabs match the cutouts in the bottom half and snap the two halves together. This should require a minimal amount of pressure, and you should hear and feel a “snap”. The fully assembled Access Point should look like the image below:



- 40 This completes the assembly of the PSR-100 WiFi Access Point. Please proceed with the next section: **Electronic Components Post-Assembly Testing**.



ELECTRONIC COMPONENTS POST-ASSEMBLY TESTING

This section will test the electronic components assembled in the previous sections. It is best to do this before they are placed inside the rotor's enclosures, making them fairly inaccessible. It is also much easier to manipulate the components in order to simplify the tests needed.

These tests require the download and installation of the PSR-100 Companion Windows Application. The link for downloading this application is:

<https://wa4mcmkits.com/wp-content/uploads/2025/05/PSR-100-Remote-Control-v1.0.1.zip>

Please download the application and follow the installation instructions in the PSR-100 Operation Manual prior to attempting to start this section.

Finally, the successful completion of the tests in this section is essential to the future success of the PSR-100 assembly. If any of the tests fail, the underlying cause must be troubleshoot and corrected before continuing with the follow-on sections of the assembly manual.

41 Plug the WiFi Hot Spot into your PC and identify its com port using the following procedure:



1. Open Device Manager:

- Method 1 (Right-click Start): Right-click on the Start button and select "Device Manager" from the menu.
- Method 2 (Search): Type "Device Manager" in the Windows search bar and select the app from the results.

2. Locate COM Ports:

- In Device Manager, expand the "Ports (COM & LPT)" section.
- If you don't see this section, make sure "Show hidden devices" is enabled (View > Show hidden devices).

3. Identify the COM Port:

- Look for the WiFi Hot Spot connected to the COM port. The COM port number will be displayed next to the name "USB Serial Device" (e.g., "USB Serial Device (COM3)").
 - If you're unsure which device is using which COM port, you can try disconnecting and reconnecting the WiFi Hot Spot while observing Device Manager to see which entry disappears and reappears.
-

- 42 Start the PSR-100 companion application. When starting the application for the first time, you may get a Com Port error as shown below:

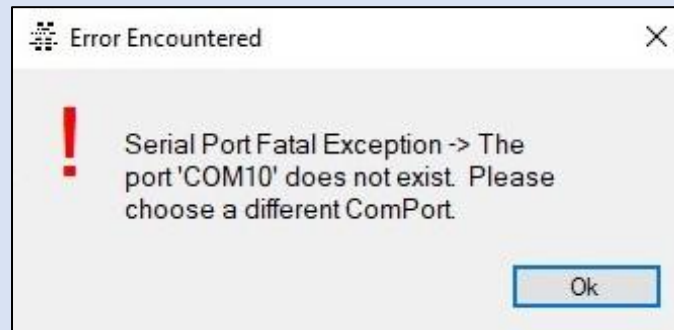

Just click the "Ok" button, and the main application window will appear.

Click on the "Settings" option on the top menu to bring up the Settings dialog box. Click on the Com Port that you identified in the previous step and click the "Save" button.

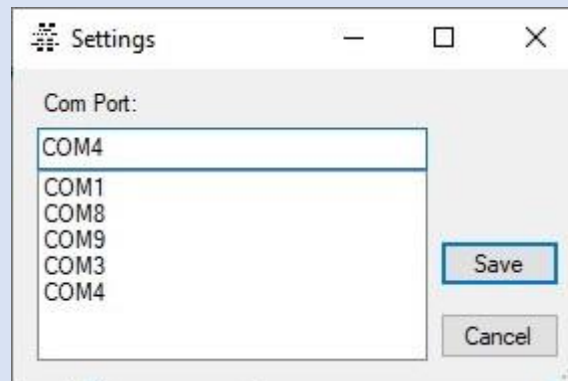

43 The application window will appear as shown below:

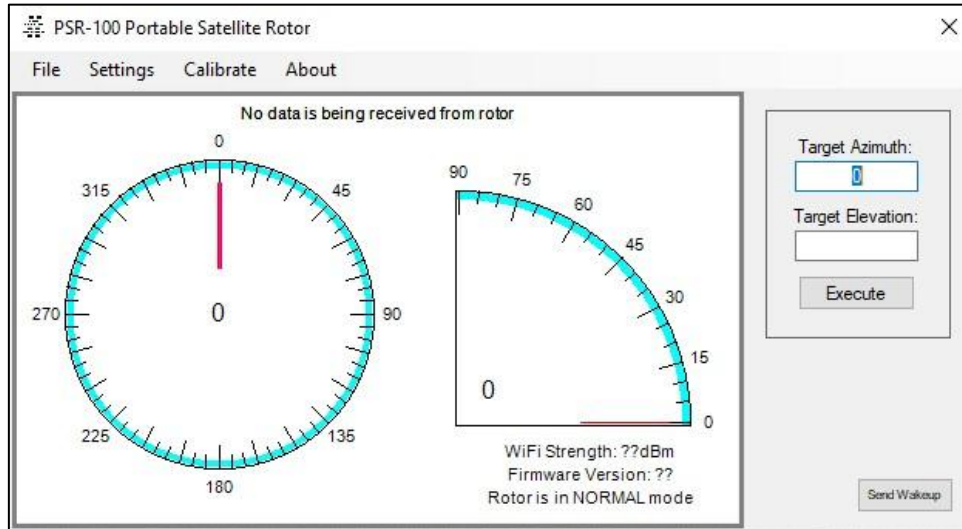

Note that there is a message stating that “No Data is being received from rotor” – this is normal at this point in the testing. You will also notice that the WiFi strength and Firmware version lines are displaying question marks.

44 Using the components onto which you soldered the wiring harnesses in the



Wire Harnesses, Switches and Az Motor Preparation section, plug them into their respective sockets on the completed main circuit board:

- **Panel Mount DC Power Receptacle** into the **Pwr** header (**CN3**)
- **SPST Toggle Switch** into the **Flip Sw** header (**CN6**)

Important Note: Please make sure that the above SPST Toggle Switch is in the Off position before plugging it into its header (CN6)

- One of the **SPDT Momentary on/off/on Toggle Switches** into the **Man Az Sw** header (**CN8**)
- The second **SPDT Momentary on/off/on Toggle Switch** into the **Man El Sw** header (**CN9**)
- **10kΩ Linear Taper Potentiometer** into the **El Pot** header (**CN5**)
- **12VDC 2rpm Motor** into the **El Motor** header (**CN2**)

45 Apply power to the circuit board by plugging the 12VDC power supply into the **Panel Mount DC Power Receptacle**.



Ensure the red LED illuminates on the MCU board.

Ensure that, after a few seconds, the “No data is being received from the rotor” message disappears from the Windows app and that the WiFi Strength and Firmware Versions are now displayed. If this doesn’t happen, click the “**Send Wakeup**” button in the lower right corner of the application window.

- 46 Click the **Calibrate** menu option – the **Calibration Procedure** window shown below will appear:

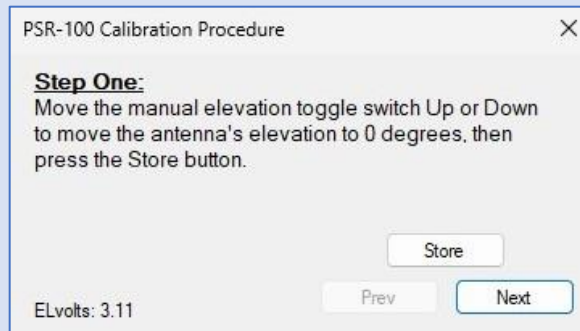

- 47 Rotate the **10kΩ Linear Taper Potentiometer** and ensure the EL volts displayed on the lower left corner of the calibration window changes.



- 48 Set the EL volts to about 1.00 and use the **SPDT Momentary on/off/on Toggle Switch** plugged into the **Man El Sw** header to make the motor move.



Moving the toggle towards the red wire should cause the motor to rotate counterclockwise when looking at the end of the shaft; moving the toggle towards the yellow wire should make it move clockwise.

Important Note: For the first few seconds after moving the toggle, the motor will exhibit some “jerky” movement. This is normal as the firmware starts each manual movement by sending widely spaced pulses to the motor to allow for very small angle movements.

- 49 Relocate the Motor and potentiometer as detailed below:



- **10kΩ Linear Taper Potentiometer** into the **Az Pot** header (**CN4**)
- **12VDC 2rpm Motor** into the **Az Motor** header (**CN1**)

- 50 Click the **Next** button on the **Calibration Procedure** window **TWICE** so that Step Three is now active (Azimuth calibration). The window will now appear as shown below:

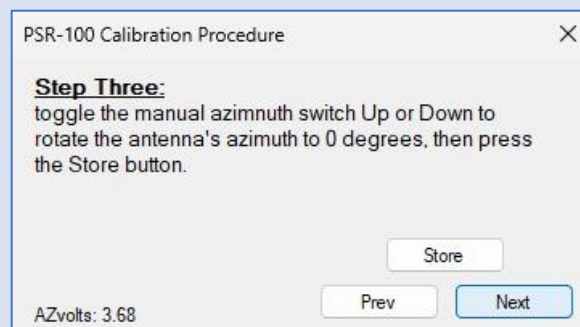

- 51 Rotate the **10kΩ Linear Taper Potentiometer** and ensure the AZ volts displayed on the lower left corner of the calibration window changes.



- 52 Set the AZ volts to about 1.00 and use the **SPDT Momentary on/off/on Toggle Switch** plugged into the **Man AZ Sw** header to make the motor move.

Moving the toggle towards the red wire should cause the motor to rotate clockwise when looking at the end of the shaft; moving the toggle towards the yellow wire should make it move counterclockwise.

Important Note: For the first few seconds after moving the toggle, the motor will exhibit some "jerky" movement. This is normal as the firmware starts each manual movement by sending widely spaced pulses to the motor to allow for very small angle movements.

- 53 Click the **Next** button on the **Calibration Procedure** window **FIVE** times until the button turns into the **Done** button. Click the **Done** button to close the calibration window and return the rotor to a regular operational mode.

- 54 Remove the **12VDC 2rpm Motor** from the **Az Motor** header.

- 55 Move the toggle of the **SPST Toggle Switch** plugged into the **Flip Sw** header to the **On** position. Ensure that the Rotor mode on the Windows companion application changes to "FLIPPED" as shown in the image to the right.

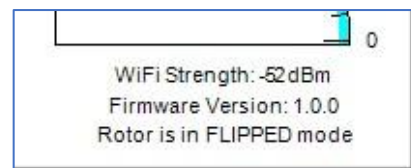

- 56 Move the toggle of the **SPST Toggle Switch** back to the **Off** position. Ensure that the Rotor mode on the Windows companion application changes back to "NORMAL"

- 57 Remove all remaining connectors from their respective headers and set the components aside to await their permanent installation during later assembly steps.

- 58 Keep the WiFi Hot Spot plugged in. Also, keep the Windows application running. They will be used in the **Final Assembly** and **Calibration and Testing** sections.

- 59 This completes the **Electronic Components Post-Assembly Testing**. Please proceed to the next section: **Mechanical Components Pre-assembly**.

MECHANICAL COMPONENTS PRE-ASSEMBLY

This section covers the assembly of all mechanical components as well as their placement into the respective main body enclosures. The main circuit board will also be installed.

MAIN BODY LAYER ONE

Layer one of the main body houses the main circuit board as well as the power receptacle and manual movement switches. Please refer to the following steps:

- 60 Use a fine point black Sharpie (or similar brand) permanent marker to “paint” the raised lettering on the outer front wall of the **Main Body Layer One**. Be very careful to only color the tops of the raised lettering.

- 61 Refer to the image on the right to understand the orientation of the **1/4-20 Brass Threaded Insert** with respect to its mounting hole in the base of layer one of the main body:

Spread a small amount of super glue around the outer circumference of the brass threaded insert and gently push it into the hole in the center of the base of **Main Body Layer One**. Use the handle of a screwdriver (or another appropriate tool) to push the insert down flush with the top of its mounting hole. You may need to strike the tool used in order to properly seat the brass threaded insert.



Please refer to the following image to view a properly installed brass threaded insert:

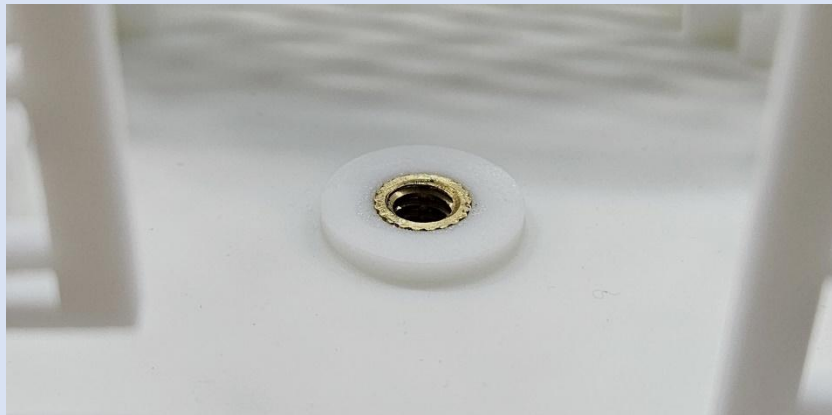

Please note that the threaded insert is installed from the INSIDE of the Main Body Layer One.

- 62 Orient the main circuit board assembly in the bottom **Main Body Layer One** such that the (4) **3-conductor JST XH PCB Headers** are closest to the square opening as shown in the image below:

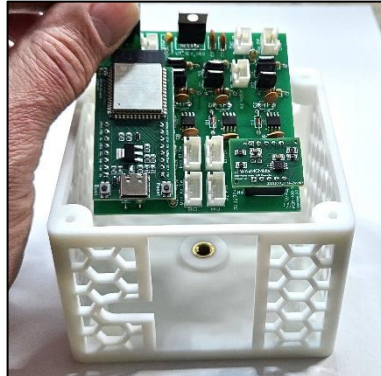

The following mounting instructions pertain to layer one configurations **PRIOR** to March of 2026



Slide the left edge of the circuit board under the lip of the anchor clip and ensure the board's corners are fitted into the left side corner supports as shown in the image on the left.

Gently push down on the right edge of the circuit board until the right side anchor clip snaps over the edge of the circuit board as shown in the right-hand image

Note: To remove the circuit board, use your thumb to push the right side anchor clip towards the right wall while gently lifting the circuit board.

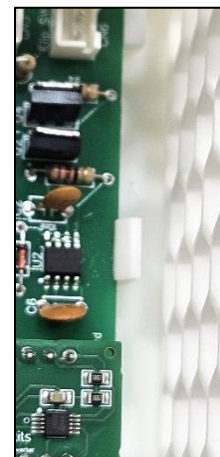

The following mounting instructions pertain to layer one configurations **BEGINNING** in March of 2026



Insert a 6-32 x $\frac{1}{4}$ " pan head machine screw into the left edge mounting block on the bottom of the main body layer one. Slide the left edge of the main circuit board under the screw's head and ensure the board's corners are fitted into the left side corner supports as shown in the image on the left.

Insert a second 6-32 x $\frac{1}{4}$ " pan head machine screw into the right edge mounting block such that the edge of the screw's head securely holds the circuit board in place.

Tighten the left edge screw.

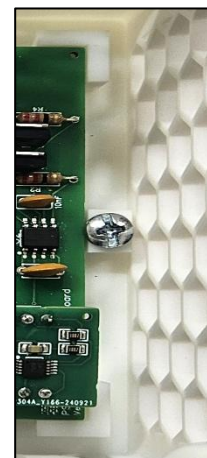

63 Plug the connector end of the **2-conductor 120mm long cable assembly** connected to the **SPST Toggle Switch** into the **Flip Sw** header (**CN6**). Just let the switch itself drape outside of the Layer One body – it will be installed in the Layer Two body later on.

64 Remove the control nut from the back of the **Panel Mount DC Power Receptacle** and insert the **2-conductor 120mm long cable assembly** and receptacle through the **12-15 Vdc** hole on the front wall of the **Main Body Layer One**.

Slide the control nut over the cable assembly and carefully screw it onto the control's threads until snug. Be very careful not to cross-thread the control nut. Use a small pair of pliers to gently tighten the control nut.

Plug the connector end of the cable assembly into the **Pwr** header (**CN3**)

65 Remove the top control nut and lock washer from one of the **SPDT Momentary on/off/on Toggle Switch Assemblies** and adjust the remaining control nut so that about $\frac{1}{4}$ " of threads is available to insert into the manual elevation switch mounting hole provided on the front wall of the **Main Body Layer One** (just above the power receptacle).

Discard the lock washer – it will not be used.

Insert the switch assembly into the manual elevation switch mounting hole from the inside of the layer one body – orient the switch such that the red wire is on top. Use the top control nut to secure the switch to the body. Tighten the nut with a $\frac{5}{16}$ " nut driver while holding the switch body to it from spinning.

Plug the connector end of the cable assembly into the **Man El Sw** header (**CN9**).

66 Remove the top control nut and lock washer from the other **SPDT Momentary on/off/on Toggle Switch Assemblies** and adjust the remaining control nut so that about $\frac{1}{4}$ " of threads is available to insert into the manual azimuth switch mounting hole provided on the front wall of the **Main Body Layer One**.

Discard the lock washer – it will not be used.

Insert the switch assembly into the manual azimuth switch mounting hole from the inside of the layer one body – orient the switch such that the red wire is on top. Use the top control nut to secure the switch to the body. Tighten the nut with a $\frac{5}{16}$ " nut driver while holding the switch body to prevent it from spinning.

Plug the connector end of the cable assembly into the **Man Az Sw** header (**CN8**).

- 67 Refer to the following images for guidance on the proper placement of all **Main Body Layer One** components:



- 68 This completes the **Main Body Layer One** pre-assembly steps. Please proceed to the next section: **Main Body Layer Two**.



MAIN BODY LAYER TWO

Layer two of the main body serves as the mounting platform for the azimuth motor. It also houses the “Flip” switch – whose connector was plugged in during the previous section. However, the switch will **NOT** be installed during this section, but rather during the final assembly section.

Please proceed with the following steps to complete the **Main Body Layer Two** pre-assembly.

- 69 Use a fine point black Sharpie (or similar brand) permanent marker to “paint” the raised lettering for the Flipped Switch located on edge of the **Main Body Layer Two**. Be very careful to only color the tops of the raised lettering as shown below:

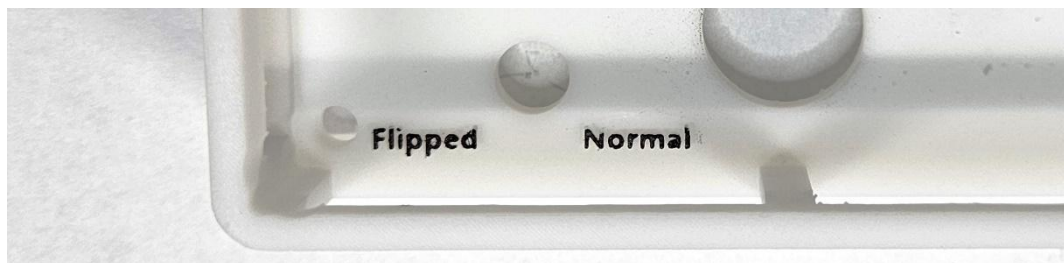

- 70 Using a 3/32" Allen wrench, insert the set screws into both set screw holes of the **6mm to 6mm set-screw shaft couplers**.

Using the motor that was pre-assembled in step 36, slide the coupler over the motor's shaft such that it's approximately 1/32" away from the motor's body as shown in the image below.

The set screws should be aligned with the shaft's flat side. Carefully tighten the bottom set screw while adjusting the coupler for a firm fit.

Tip: when inserting the set screws, screw them in so that they protrude very slightly into the coupler's center hole. This will ensure that the coupler can only be installed with the set screws facing the shaft's flat side.



- 71 Mount the azimuth motor using (4) **M3 x 6mm Pan Head Screws**. Align the motor as shown in the picture below. **Ensure that the coupler is centered in the opening.**



72



Insert one of the **6mm x 60mm D Shafts** into the opening at the top of the **6mm to 6mm set-screw shaft coupler** such that the shaft's flat side is facing the coupler's set screws. Carefully tighten the top set screw while adjusting the coupler for a firm fit.

73



This completes the **Main Body Layer Two** pre-assembly steps. Please proceed to the next section: **Main Body Layer Three**.

MAIN BODY LAYER THREE

Layer three of the main body houses the **10k Ω Linear Taper Potentiometer** that transmits the azimuth angle to the PSR-100's microcontroller. It will be mounted along with one of the **45 Tooth Hub-mount Gears**.

Please proceed with the following steps to complete the **Main Body Layer Three** pre-assembly.

74



Remove the control nut and top washer from the threaded shaft of the **10k Ω Linear Taper Potentiometer** that was pre-assembled in step 32.

From the underside of **Main Body Layer Three**, insert the threaded shaft into the hole located in the layer's corner. Rotate the potentiometer such that its "tab" will fit into the cutout provided in the layer as shown in the image to the right.

Place the top washer over the threaded shaft and secure the potentiometer using the control nut. Use a 7/16" nut driver to tighten the control nut. **Be careful not to overtighten.**



- 75 Locate the **1/4" Bore Set-screw Hub** and use a 2.5mm Allen wrench to loosely insert its set screw into the hub's threaded receptacle.



Locate the **45 Tooth Hub-mount Gear**. Identify the round holes in the gear -vs- the elongated holes as shown in the image to the left.

Using (2) M4 x 10mm Pan Head Screws, secure the gear hub via two of the round holes identified above. Use two holes that are on opposite sides of the center hole in the gear.



- 76 Turn the shaft of the azimuth angle potentiometer mounted in step 74 above fully counterclockwise.
 Mount the azimuth gear/hub assembly to the shaft such that the set screw is facing the wall of the layer as shown in the image.

Tighten the set screw using a 2.5mm Allen wrench.

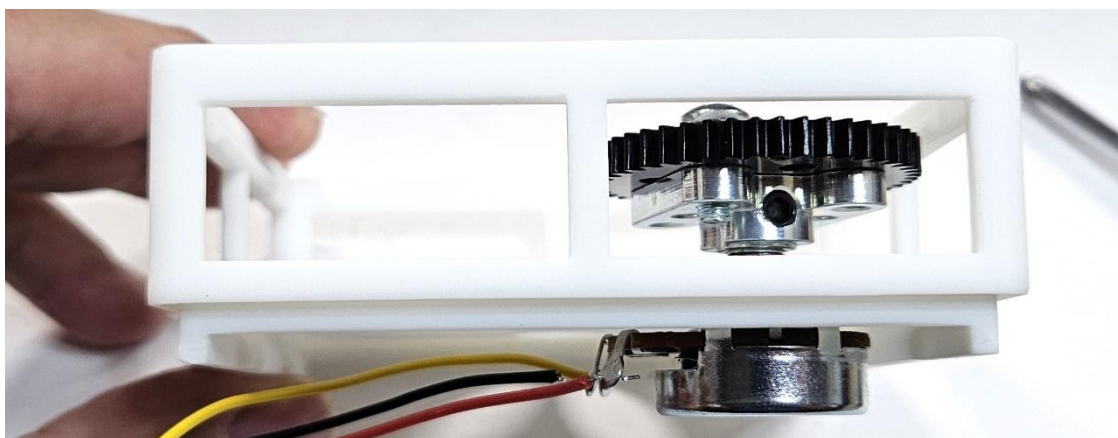

- 77 This completes the **Main Body Layer Three** pre-assembly steps. Please proceed to the next section: **Elevation Motor Mounting Bracket**.

ELEVATION MOTOR MOUNTING BRACKET

The elevator mounting bracket holds all the components for elevating the antenna as well as acts as the actual platform for the antenna itself. Therefore, it is connected to the azimuth motor's shaft and rotates on a ball bearing turntable.

- 78 Install one the two **6mm I.D. x 14mm O.D Ball Bearings** on the bracket's vertical arm that has the four small holes meant to secure the elevation motor. Insert the smaller side of the bearing from the outside of the arm and press it towards the center until its outer rim is flush with the bracket.

You will note that there is a recessed edge on the outside of the bracket's opening to receive the rim of the bearing assembly. Please refer to the image to the right for an illustration of the proper installation of this bearing.

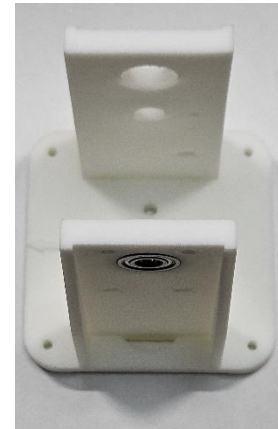

- 79 Insert the shaft of the second **12VDC 2rpm Motors** (the one with no wires yet) into the bearing that was installed in the previous step.

Use the (4) remaining **M3 x 6mm Pan Head Screws** to secure the motor to the bracket. You will have to insert your screwdriver through the upper bearing opening on the other bracket arm in order to reach the upper two screws, and the lower opening (meant for the elevation angle potentiometer) to reach the bottom two screws. Refer to the photo below for guidance:



- 80 As you did in step 78, Install the remaining **6mm I.D. x 14mm O.D Ball Bearing** on the bracket's other arm. Insert the smaller side of the bearing from the outside of the arm and press it towards the center until its outer rim is flush with the bracket.

- 81 Prepare the **6mm D-bore Single Sonic Hub** by inserting its (2) socket head screws into their respective threaded receptacles and loosely screwing them in - they will be tightened during the final assembly.

Now, install the hub into the recessed mounting hole in the base of the bracket.

Note: One side of the sonic hub has a raised, circular "key". The recessed portion of the mounting hole is designed to accept this key and ensure the hub is perfectly centered on the bracket.

Use (2) **M4 x 10mm Pan Head Screws** to secure the hub to the bracket. Insert the screws from the bottom of the bracket. The hub's mounting holes are threaded to accept the screws.



- 82 Remove the control nut and top washer from the threaded shaft of the second **10kΩ Linear Taper Potentiometer**.

From the inside of the bracket arm opposite from the motor, Insert the threaded shaft into the hole located below the bearing that was installed in step 80. Rotate the potentiometer such that its "tab" will fit into the cutout provided in the bracket arm as shown in the image to the right.

Place the top washer over the threaded shaft and secure the potentiometer using the control nut. Use a 7/16" nut driver to tighten the control nut. **Be careful not to overtighten.**



- 83 Prepare the **6mm D-bore Double Sonic Hub** by inserting its (4) socket head screws into their respective threaded receptacles and loosely screwing them in - they will be tightened during the final assembly.

Now, install the hub into the recessed mounting hole at the end of the **Lower Antenna Mounting Arm**. Install the hub on the side of the arm WITH the raised ribs at its end as shown in the right-hand image below.

Note: One side of the sonic hub has a raised, circular "key". The mounting hole is designed to accept this key and ensure the hub is perfectly centered on the arm.

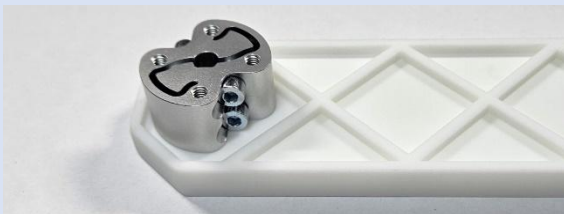

Use (2) **M4 x 10mm Pan Head Screws** to secure the hub to the arm. Insert the screws from the opposite side of the arm. The hub's mounting holes are threaded to accept the screws.

- 84 Mount the elevation arm assembly to the motor shaft by carefully slipping the end with the Sonic hub between the end of the shaft and the elevation angle potentiometer as shown in the image below.

Align the flat side of the hub's center hole with the flat on the motor's shaft and slide the hub onto the shaft. **Do not tighten the hub's screws yet.**

Important Note: if the arm won't fit when the flat sides are aligned – mainly due to it contacting the bottom of the elevation bracket, you will need to withdraw the arm, remove the hub and rotate it 180°, then remount it. Once the hub has been remounted, retry mounting the arm assembly to the elevation motor's shaft.



- 85 Slide the second **6mm x 60mm D Shaft** through the opening in the **6mm I.D. x 14mm O.D Ball Bearing** mounted in the elevation bracket above the potentiometer and then into the opening in the sonic hub on the elevation arm assembly.

Position the hub so that it is approximately $\frac{1}{8}$ " away from the elevation motor's mounting bracket, then ensure that the shaft is inserted into the hub as far as it can go.

Use a 3mm Allen wrench to tighten the four elevation arm hub's screws. **Do not overtighten the screws.**

- 86 Prepare the **15 Tooth 1/4" Bore Pinion Gear** by inserting its set screw into the threaded hole on the side of the gear using a 2.5mm Allen wrench.

Slide the pinion gear onto the shaft of the elevation potentiometer such that you can still reach the set screw and tighten the set screw using the Allen wrench.

Please refer to the image to the right for the correct alignment of the pinion gear.



- 87 Prepare one of the **30 Tooth, 6mm D-Bore Pinion Gears** by inserting its socket head setscrew into its threaded receptacle and loosely screwing it in so that it just "peeks" inside the gear's shaft opening.

- 88 Slide the **30 Tooth, 6mm D-Bore Pinion Gear** that you prepared in the previous step onto the end of the elevation shaft as shown in the picture below.

Position the hub so that the gear teeth do not yet mesh with the teeth of the **15 Tooth 1/4" Bore Pinion Gear**. Leave the hub's socket head screws snug, but not tight. You will be sliding the hub/gear assembly inward to mesh with the pinion gear later on in the *Calibration and Testing* section.

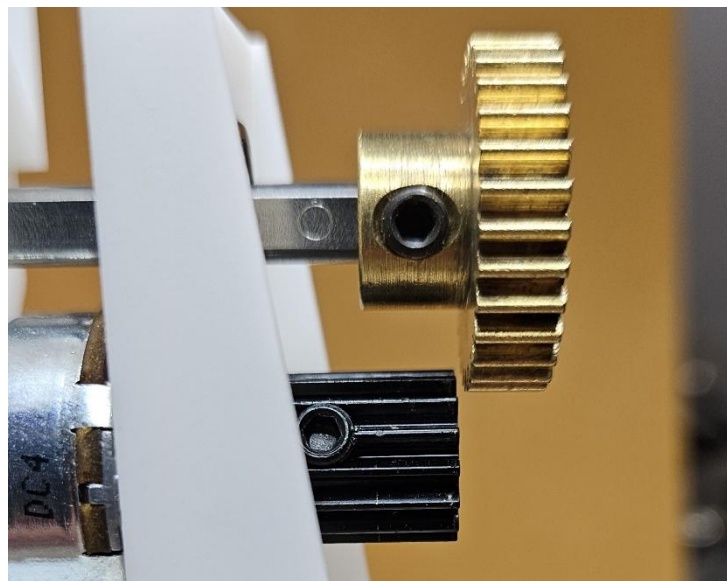

- 89 Mount the **3" Square Ball Bearing Turntable** to the bottom of the using (4) **6-32 x 1/4" pan head machine screws**.

Caution! Do not overtighten the screws. As you can imagine, the 3-D printed threads in the bottom of the elevation bracket can be easily stripped if overtightened.

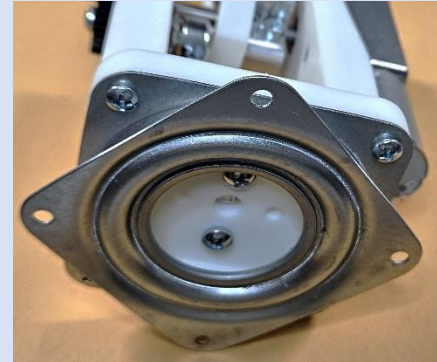

- 90 This completes the **Mechanical Components Pre-assembly** section of the assembly. Please proceed to the next section: **Final Assembly**.

FINAL ASSEMBLY

- 91 Remove the top control nut and lock washer from the **SPST Toggle Switch** that was plugged into the main circuit board in step 63. Screw the bottom control nut so that it is approximately 1/16" from the body of the switch.

Insert the threaded shaft of the switch into the hole provided in the **Main Body Layer Two**. Insert the switch from the bottom of the layer. Ensure that the side of the switch that contains the "On" and "Off" markings is facing the outer rim of the layer two body as shown in the image below.

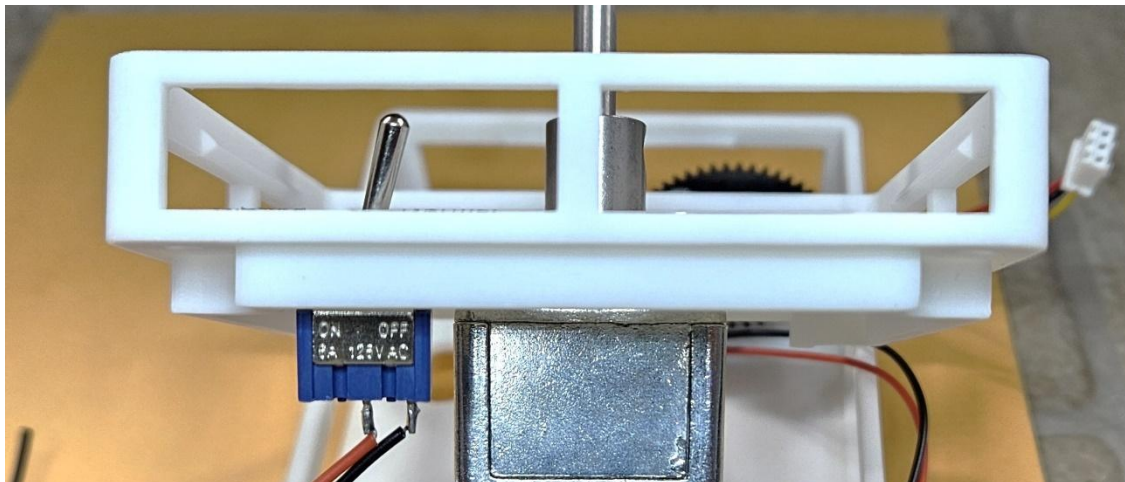

Place the lock washer over the threaded shaft and secure the switch to the layer using the top control nut. Tighten the nut using a 5/16" nut driver.

- 92 Locate the elevation motor cable assembly created in step 29. Plug its connector into the **EI Motor** header (**CN2**) on the **PSR-100 Main Board**.

- 93 Locate the elevation potentiometer cable assembly created in step 30. Plug its connector into the **EI Pot** header (**CN5**) on the **PSR-100 Main Board**.

- 94 Plug the connector of the azimuth motor cable into the Az Motor header (**CN1**). You will have to position the **Main Body Layer Two** such that the Azimuth Motor's wired end is slightly above the **Main Body Layer One**.

While continuing to hold the **Main Body Layer Two** above the layer one body, route the 2 elevation cable assemblies (installed in the previous 2 steps) through the hole situated next to the flip switch.

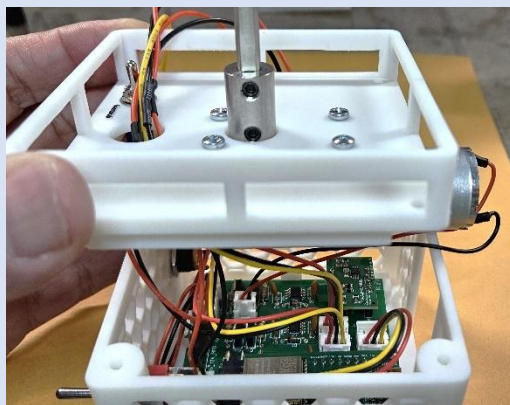

95

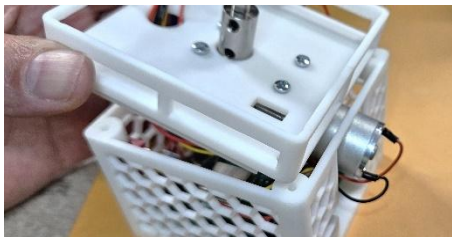

Carefully tilt the **Main Body Layer Two** so that the azimuth motor will slide into the large opening on the side of the **Main Body Layer One** as shown in the image to the left:

Ensure the cables that were routed in the previous step remain in their hole and that you do not dislodge the azimuth motor's cable assembly from its home in header **CN1**.

Fit the **Main body Layer Two** onto the top of the **Main Body Layer One** and secure it with (4) **6-32 x 1/4" pan head machine screws**. Take care that none of the cable assemblies are pinched between the two layers.

Caution! Do not overtighten the screws. As you can imagine, the 3-D printed threads in the bottom of the can be easily stripped if overtightened.

Refer to the picture on the right for the properly assembled layers one and two.

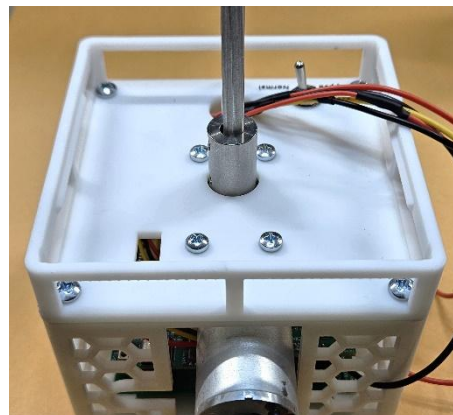

96

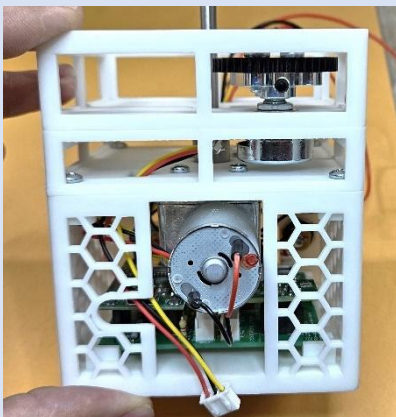

While holding the **Main Body Layer Three** above the layer two body, route the 2 elevation cable assemblies that are coming from layer one through the corresponding routing hole in the floor of layer three.

Likewise, route the azimuth potentiometer cable assembly through the rectangular hole provided in the floor of layer two.

Route the cable assembly as shown in the photo to the left.

Snap the Main Body Layer Three to the Main Body Layer Two.

- 97 Use a pair of needle nose pliers to plug the azimuth potentiometer cable assembly into the Az Pot header (CN4). Refer to the image below for guidance.

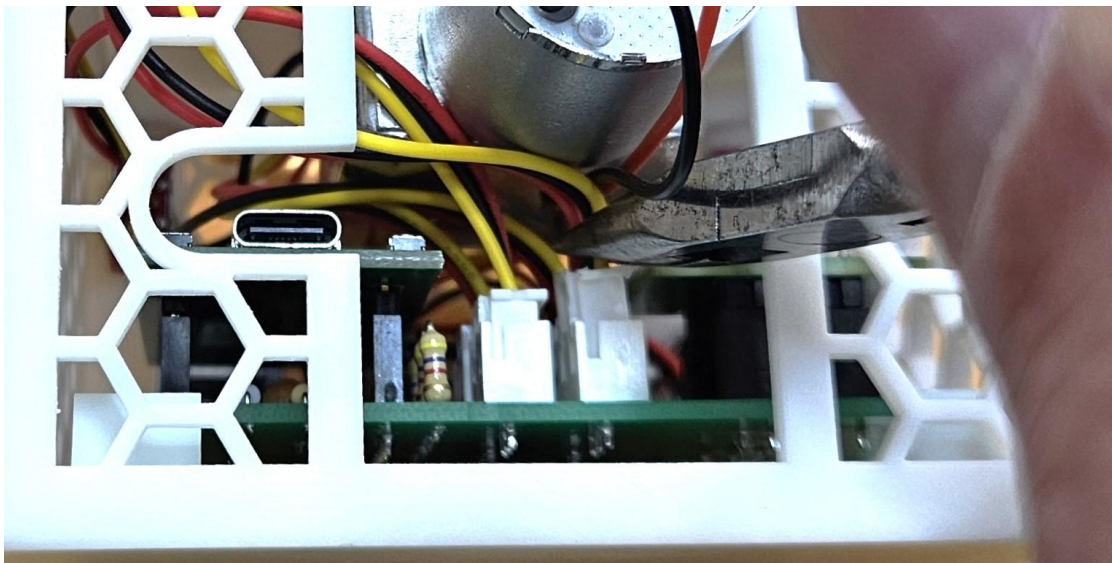

- 98 Prepare the **30 Tooth, 6mm D-Bore Pinion Gear** by inserting its socket head setscrew into its threaded receptacle and loosely screwing it in so that it just “peeks” inside the gear’s shaft opening. Slide the gear onto the azimuth shaft and gently mate its teeth with those of the azimuth potentiometer gear. Continue to slide the gear towards the azimuth motor until it contacts the shaft coupler that was install in step 70. The teeth of the two gears should no longer be engaged. This is normal for now – this pinion gear will be raised and secured during the **Calibration and Testing** section.

Please refer to the image on the right for guidance.

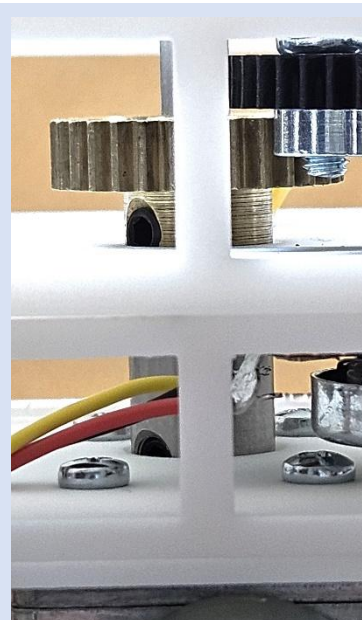

The purpose of the next seven steps is to set up the rotor assembly so that you can temporarily position the azimuth motor’s shaft so that it will point the antenna’s mounting arm at zero degrees. From this position, the rotor will only be allowed to rotate clockwise as it is a hard, mechanical stop for any further counterclockwise movement.

Once in this position, we will continue with the normal final assembly steps starting with the routing of the elevation wiring assemblies around the azimuth shaft to ensure they do not become wrapped too tightly around the shaft.

- 99 Temporarily route the cable assemblies through one of the side windows of the **Main Body Layer Three** as shown below:

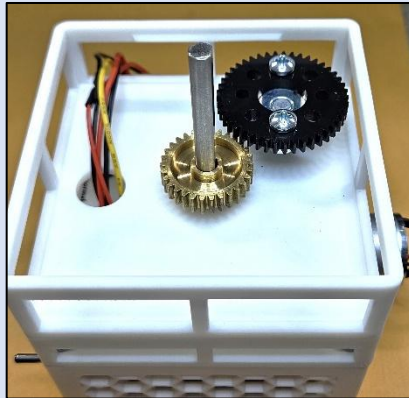

This is to allow the temporary installation of the **Main Body Top Plate**.

- 100 Temporarily place the **Main Body Top Plate** onto the **Main Body Layer Three** by orienting it as shown below, then snapping it onto the layer three body.



- 101



Orient the hub opening in the base of the **Elevation Motor Mounting Bracket** so that its flat side is aligned with the flat side of the azimuth motor shaft protruding from the **Main Body Top Plate**.

Gently slide the hub onto the azimuth motor shaft – loosen the hub's screws if necessary. The **Elevation Motor Bracket** assembly should now be sitting on the **Main Body Top Plate**. Refer to the photo on the left.

- 102 Ensure the WiFi Hot Spot and Windows PSR-100 Companion application are still active, then apply 12VDC to the rotor's DC power receptacle.
- Watch the Windows application's screen to verify that the **"No data is being received from the rotor"** message disappears after a couple of seconds. This indicates that the rotor has established a connection with the application.
- 103 Note the azimuth angle being displayed on the application. If it is zero, use your finger to slowly rotate the azimuth potentiometer's 45 tooth gear until the angle reads any non-zero value.
- Note: the reason for this step is to fool the rotor's microcontroller that it is safe to manually rotate the azimuth motor in either direction.**
- 104 Click the **Calibrate** menu option to, once again, place the rotor into calibrate mode.
- Note: the reason for this step is the fact that the manual movement toggle switches are not enabled unless the rotor is in calibrate mode.**
- 105 Use the manual azimuth movement toggle switch either clockwise (CW), or counterclockwise (CCW) to rotate the Elevation Motor Mounting Bracket so that the raised arrow on the upper side of the bracket's base is pointing to the center of the side of the main body that contains all the toggle switches. Please refer to the images below for guidance:

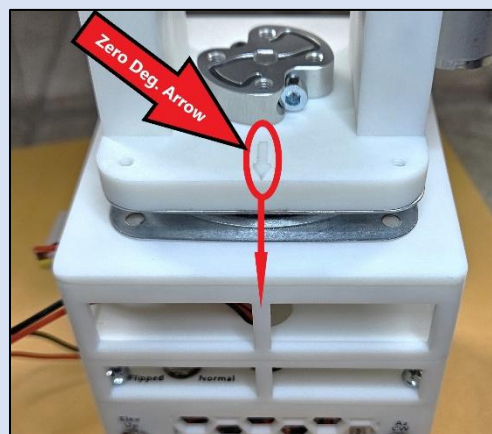
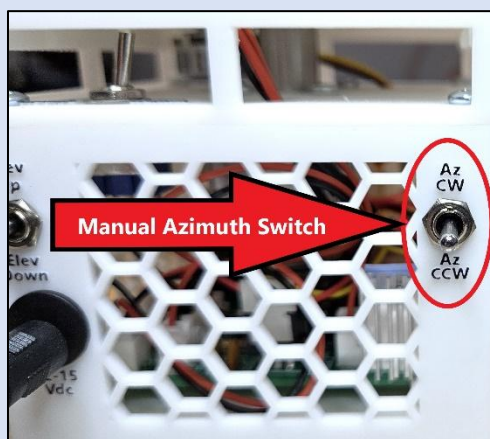

Note: This is considered the zero degree location.

- 106 On the calibration procedure window, click the **Next** button repeatedly until it changes into the **Done** button, then click it once more to exit out of the calibration procedure.
- 107 Remove the power cable for now.

The azimuth shaft positioning steps are now complete – please continue with the remainder of the Final Assembly.

- 108 Carefully remove the **Elevation Motor Mounting Bracket** from the **Main Body Top Plate** by carefully sliding the bracket's base hub off of the azimuth motor's shaft.

- 109 Remove the **Main Body Top Plate** from the **Main Body Layer Three** and set it close to the layer so that the elevation wiring assemblies can be routed through their top plate channel.

Route all five wires – first, between the bottom of the top plate and the gear protection shelf, then by clipping the wires inside the retaining clip as shown in the photo to the right.

Flip the Main Body Top Plate over and press it onto the Main Body Layer Three until it snaps into place.



- 110 Loosen the four **6-32 x 1/4" pan head machine screws** attaching the **3" Square Ball Bearing Turntable** to the base of the **Elevation Motor Mounting Bracket** in order to provide enough room to snake the elevation motor and elevation angle potentiometer wiring assemblies into their respective channels – an extra 1/8" should be sufficient.

- 111 Route the elevation motor wires as shown in the photos below:



Note: You can easily distinguish between the elevation motor wires and the black and red elevation potentiometer wires – the motor wires will be longer than the potentiometer wires.

Tip: Putting a small bend in the end of each wire will make it easier to snake the wire into the opening provided in the Elevation Motor Mounting Bracket's base.

112 Route the azimuth potentiometer wires as shown in the image below:



Tip: Putting a small bend in the end of each wire will make it easier to snake the wire into the opening provided in the Elevation Motor Mounting Bracket's base.

113 Retighten the (4) **6-32 x 1/4"** pan head machine screws attaching the **3" Square Ball Bearing Turntable** to the base of the **Elevation Motor Mounting Bracket**.



Caution! Do not overtighten the screws. As you can imagine, the 3-D printed threads in the bottom of the can be easily stripped if overtightened.

- 114 Ensure the elevation wires are routed counterclockwise around the shaft as shown in the picture below.

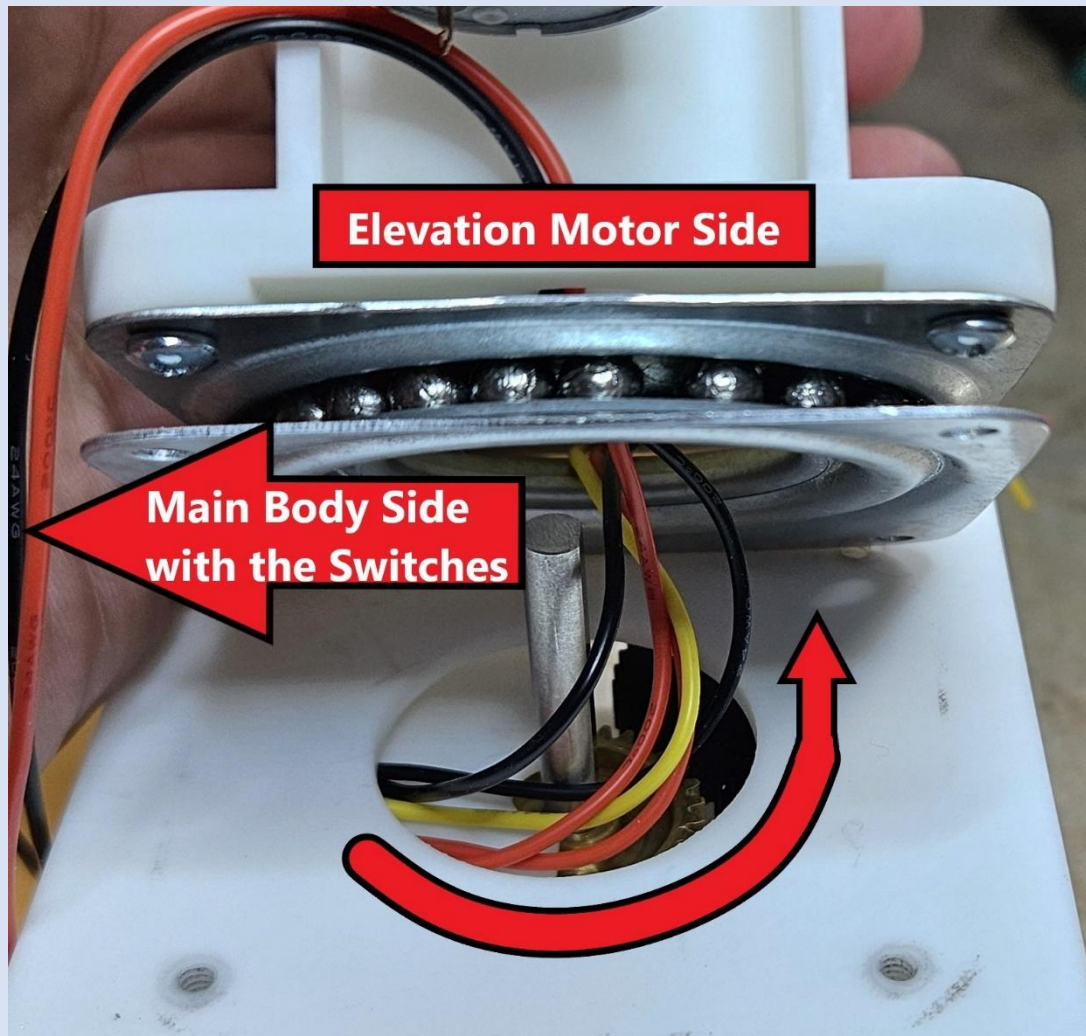

Also ensure that the excess slack has been pulled out of the wires so that they appear as they do above.

- 115 Slide the **Elevation Motor Mounting Bracket's** base hub onto the azimuth motor shaft while ensuring the elevation motor wires are not being pinched by the turntable.



Use a 3mm Allen wrench to tighten the two socket head screws on the bracket's base hub. Put a slight downward pressure while tightening the screws to ensure that the Main Body layers are held tightly together.

- 116 Apply 12VDC to the power receptacle and use the manual azimuth toggle switch to rotate the **Elevation Motor Mounting Bracket** as needed to allow you secure the turntable to the **Main Body Top Plate**. Use (4) **6-32 x 1/4"** pan head machine screws.



Caution! Do not overtighten the screws. As you can imagine, the 3-D printed threads in the Main Body Top Plate can be easily stripped if overtightened.

Once finished, use the manual azimuth toggle switch to return the **Elevation Motor Mounting Bracket** to the zero degree location as was done in step 105.

- 117 Remove the 12VDC power source from the power receptacle.



- 118 Route the elevation potentiometer wires through the small hole below and to the left of the elevation potentiometer's shaft as shown in the image to the right.



Leave a little slack in wires when pulling them through the opening.



- 119

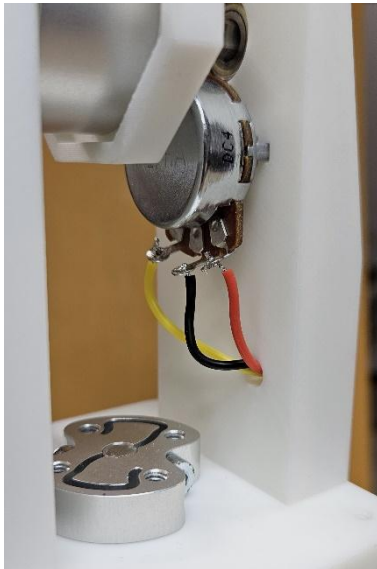

Prepare the elevation potentiometer wires by trimming them to a length where they can easily reach the elevation potentiometer's solder lugs but won't create a large "loop" when hooked up. Discard the wire pieces that you removed.

Strip about $\frac{1}{4}$ " of insulation off of each wire and twist and tin the exposed wires.

Connect each wire to its respective solder lug on the elevation potentiometer as shown in the image to the left. Trim any excess wire after soldering.

120

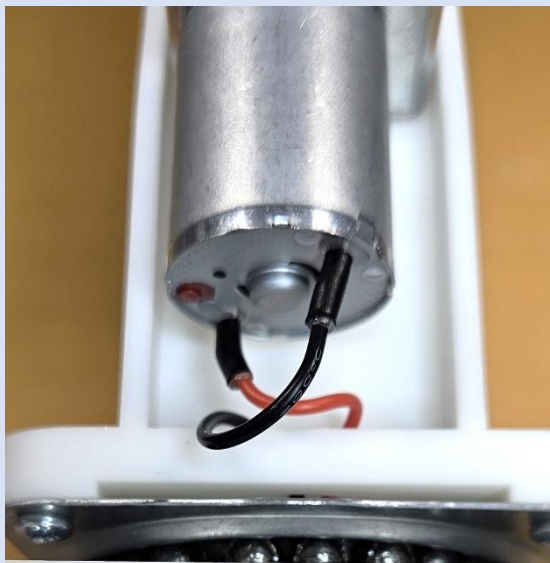

Prepare the elevation motor wires by trimming them to a length where they can easily reach the elevation motor's solder lugs but won't create a large "loop" when hooked up. Discard the wire pieces that you removed.

Strip about $\frac{1}{4}$ " of insulation off of each wire and twist and tin the exposed wires.

Cut two $\frac{1}{4}$ " pieces of heat shrink tubing

Slide a piece of heat shrink tubing over each wire, then connect and solder each wire to its respective solder lug on the elevation motor as shown in the image to the left. The **RED** wire connects to the solder lug with the red spot next to it. The **BLACK** wire to the other solder lug.

Trim any excess wire after soldering, then slide the heat shrink tubing over the solder lug and use a heat gun to shrink the tubing.

121



Ensure that the WiFi Hot Spot is still plugged into your computer and the PSR-100 companion application is still running as instructed in step 58.

Apply 12VDC to the power receptacle and ensure that the "No data is being received from the rotor" message at the top of the application's screen disappears after a few seconds.

122



Use the manual elevation toggle switch to rotate the **Lower Antenna Mounting Arm** so that it is straight up and down (zero degrees elevation).

Note: you may need to slightly rotate the elevation potentiometer so that it sends a non-zero degree reading to the microcontroller in order to get the arm to move.

123



This completes the physical assembly of the PSR-100 Portable Satellite Antenna Rotor.

Please leave the WiFi Hot Spot and the PSR-100 companion application running. Also keep power applied to the rotor.

Please proceed to the next section: **Calibration and Testing**

CALIBRATION AND TESTING

This is the final section of the step-by-step assembly instructions.

In this section you will be using the PSR-100 companion Windows application to perform the gear and potentiometer alignment procedures for the azimuth and elevation gear trains. You will also be using the application to calibrate the rotor's azimuth and elevation angles as being transmitted by the respective potentiometers.

ELEVATION POTENTIOMETER

Please perform the following steps to complete the elevation potentiometer installation as well as its calibration.

- 124 Open the companion application's calibration procedure by selecting "Calibrate" from the top menu.

The calibration dialog box as shown in the image to the right will appear.

The calibration procedure is a guided, step-by-step process that will ensure that both the elevation and azimuth gear trains provide the most accurate angle measurements.

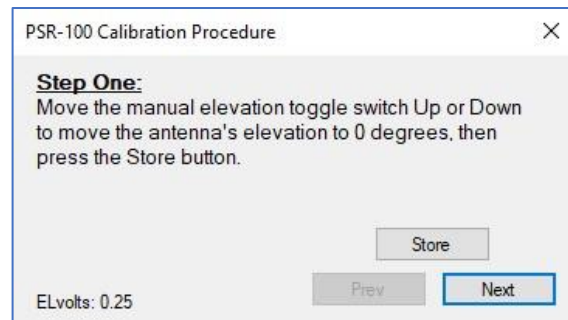

- 125 Ensure that the **Lower Antenna Mounting Arm** is still straight up and down (zero degrees elevation) as performed in step 122. If not, use the manual elevation toggle switch to achieve this.
Use your fingers to adjust the elevation potentiometer so that the **ELvolts** value as seen in the lower left corner of the calibration dialog box is between 0.15 and 0.25.

- 126

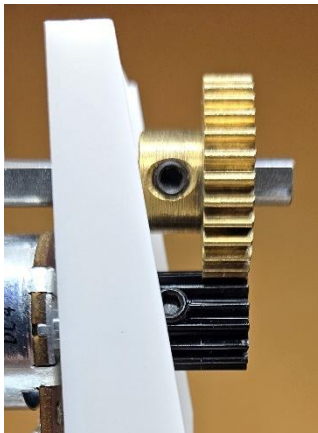

Slide the **30 Tooth, 6mm D-Bore Pinion Gear** inward to carefully mesh with the elevation potentiometer pinion gear. The gear/hub assembly should be fully engaged with the pinion gear as shown in the image to the left.

Caution: Ensure that the elevation hub/gear assembly has not been slid too far as this may cause it to interfere with the pinion gear's set screw.

- 127 Use a 2.5mm Allen wrench to tighten the socket head screw on the elevation gear hub.

- 128 Ensure the **ELvolts** value still reads within the range between 0.15 and 0.25. Redo the previous 3 steps if the voltage has strayed outside this range.

- 129 Click the **Store** button and ensure the stored message similar to the one shown below is displayed.

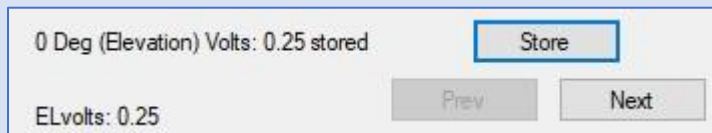

Once you receive the message, click the **Next** button to move to step two of the guided calibration process.

- 130 As instructed in the step two text, use the manual elevation toggle switch to move the **Lower Antenna Mounting Arm** so that it is at 90 degrees (Horizontal).



- 131 Click the **Store** button to store the 90 degree **ELvolts** reading.



The 90 Deg stored message should appear shortly after clicking the **Store** button.

Once you receive the message, click the **Next** button to move to the azimuth portion of the guided calibration process.

- 132 Please proceed with the next section: ***Azimuth Potentiometer***.



AZIMUTH POTENTIOMETER

Please perform the following steps to complete the azimuth potentiometer installation as well as its calibration.

- 133 The calibration procedure dialog box should now be at step three as shown in the image to the right:



Use your finger to adjust the azimuth pot gear so that the **AZvolts** value is between 0.15 and 0.25.

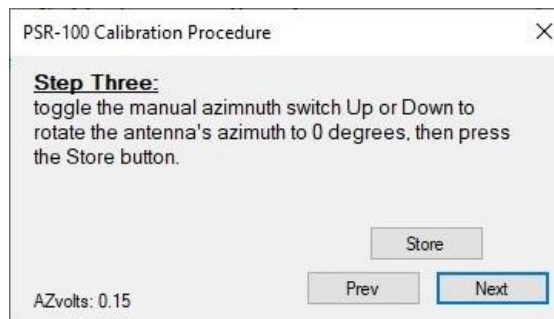

- 134 Slide the azimuth pinion gear up so that its teeth mesh those of the azimuth potentiometer gear's teeth.



- 135 While holding the pinion gear in position, use a 2.5mm Allen Wrench to tighten its socket head set screw.



- 136 Ensure the **AZvolts** value still reads within the range between 0.15 and 0.25. Redo the previous 3 steps if the voltage has strayed outside this range.



- 137 Click the **Store** button and ensure the stored message similar to the one shown below is displayed.

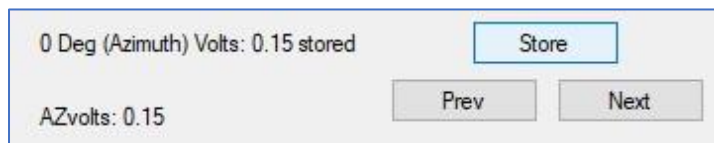

Once you receive the message, click the **Next** button to move to step four of the guided calibration process.

- 138 As instructed in the Calibration Procedure's Step Four text, use the manual azimuth toggle switch to rotate the **Elevation Motor Mounting Bracket** so that it is at 90 degrees.



Tip: To easily judge the 0, 90, 180, 270 and 360 degree positions, use the CW and CCW positions of the manual azimuth toggle switch to line up the edges of the upper and lower parts of the turntable as shown in the image below.



- 139 Click the **Store** button to store the 90 degree **AZvolts** reading.



The 90 Deg stored message should appear shortly after clicking the **Store** button.

Once you receive the message, click the **Next** button to move to step five of the guided calibration process.

- 140 As instructed in the Calibration Procedure's Step Five text, use the manual azimuth toggle switch to rotate the **Elevation Motor Mounting Bracket** so that it is at 180 degrees.



- 141 Click the **Store** button to store the 180 degree **AZvolts** reading.



The 180 Deg stored message should appear shortly after clicking the **Store** button.

Once you receive the message, click the **Next** button to move to step six of the guided calibration process.

- 142 As instructed in the Calibration Procedure's Step Six text, use the manual azimuth toggle switch to rotate the **Elevation Motor Mounting Bracket** so that it is at 270 degrees.



- 143 Click the **Store** button to store the 270 degree **AZvolts** reading.
- The 270 Deg stored message should appear shortly after clicking the **Store** button.
- Once you receive the message, click the **Next** button to move to step seven of the guided calibration process.
- 144 As instructed in the Calibration Procedure's Step Seven text, use the manual azimuth toggle switch to rotate the **Elevation Motor Mounting Bracket** so that it is at 360 degrees.
-
- 145 Click the **Store** button to store the 360 degree **AZvolts** reading.
- The 360 Deg stored message should appear shortly after clicking the **Store** button.
- Once you receive the message, click the **Next** button to move to the last step of the guided calibration process.
- 146 Click the Done button to complete the PSR-100 calibration process.
- Congratulations! You have completed the assembly of your PSR-100 Portable Satellite Antenna Rotor. Please proceed to the next, and final, section: **Live Testing**.

LIVE TESTING

This section will run through several tests to ensure that the rotor's calibration is within specs. It will also test the "Flip" switch that will move the physical CW stop to the 180 degree position and the CCW physical stop to the 181 degree position.

- 147 Using the PSR-100 companion Windows application, enter **180** in the **Target Azimuth** field and **45** in the **Target Elevation** field, then click the Execute button.
-
- Note that the rotor begins moving to these new azimuth and elevation angles.
- 148 Using the PSR-100 companion Windows application, enter **270** in the **Target Azimuth** field and **90** in the **Target Elevation** field, then click the Execute button.
-
- Note that the rotor begins moving to these new azimuth and elevation angles.
- 149 Using the PSR-100 companion Windows application, enter **0** in the **Target Azimuth** field and **0** in the **Target Elevation** field, then click the Execute button.
-
- Note that the rotor begins moving to these new azimuth and elevation angles.
- 150 Use your finger (or any object that can access it such as a pen or pencil) move the **Flipped Mode Toggle Switch** to the **Flipped** position.
-
- Note that the rotor immediately starts to rotate clockwise to the (formerly) **180** degree position. Also note that the PSR-100 companion Windows application tracks from **180** degrees to **360** degrees but then displays **0** degrees once movement stops. While in flipped mode the new **0** degree position is **180** degrees opposite that of Normal mode.
- Flipped mode is used when you know that the satellite being tracked will be pass north of your position. Normally this would require the rotor to turn backwards through 360 degrees when transitioning between 0 degrees and 360 degrees due to the physical stop. Flipped mode allows the rotor to seamlessly transition since the physical stop has been moved to the 180 degree position.

151 While in flipped mode, re-run the angle tests performed in steps 147 through 149.



152 Use your finger (or any object that can access it such as a pen or pencil) move the **Flipped Mode Toggle Switch** to the **Normal** position.



Note that the rotor immediately starts to rotate counterclockwise to the original **0** degree position. Also note that the PSR-100 companion Windows application tracks from **180** degrees to **0**.

153 Your PSR-100 is now ready for use.



TROUBLESHOOTING

Before reviewing Table 4 below for possible solutions to your problem, please take time to inspect the following items carefully and thoroughly:

- **Solder Joints** – Bad solder joints are the single most common cause of non-working electronics projects.
- **Correct diode polarity** – Make sure that the white (or black) band is pointing in the correct direction.
- **Correct voltage regulator orientation** – Ensure their tabs match their circuit board outlines.
- **JST XH PCB header orientation** – Ensure all JST XH headers (CN1-CN9) are oriented as indicated by their circuit board outlines as well as the assembly instructions.
- **N-channel power MOSFET orientation** - Ensure their tabs match their circuit board outlines (Q1-Q8).
- **12VDC 2rpm Motor wiring** – Ensure the red wire is connected to the solder lug next to the red dot.
- **AZ and EL angle potentiometer wiring** – Ensure that the correct color wires are connected to their respective solder lugs as shown in their assembly steps (step **32** for AZ; step **119** for EL)
- **PSR-100 Microcontroller Module (MCU) installed correctly** – Ensure that the MCU board’s WiFi antenna is situated above Q5 and Q7.
- **Analog to Digital Converter (ADC) Module Installed correctly** – Ensure that pin 1 on the module mates up with Pin 1 on the circuit board’s header H3.

When reviewing the possible solutions in Table 4, all measurements are made between the point named in the text and the power connector’s ground (black wire) unless otherwise noted in the text. Likewise, any test that requires applying a voltage will be made referenced to this same ground.

Table 4 - Troubleshooting Matrix

Symptom	Possible Solutions	
The PSR-100 Microcontroller’s red power LED does not illuminate	Check for: <ul style="list-style-type: none"> • +5VDC on Pin 1 of the MCU’s H2 (see image below) 	If measurement is bad: <ul style="list-style-type: none"> • Bad solder joint on either the MCU’s male H2 header, or the Main Board’s female H2 header. • Bad +5VDC Linear Regulator (U2)
	<ul style="list-style-type: none"> • Above measurement is good 	<ul style="list-style-type: none"> • Faulty MCU Board – Contact WA4MCMkits

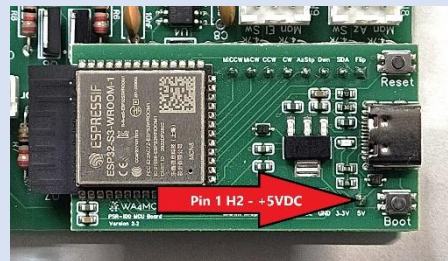

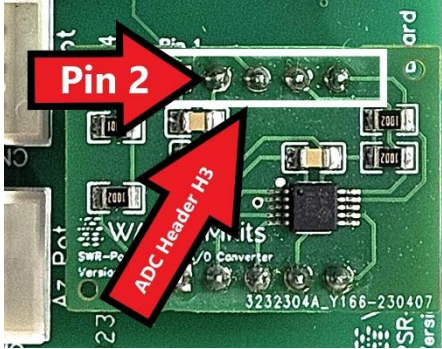
<p>The “No Data is being received from rotor” message at the top of the companion application’s azimuth and elevation angle window doesn’t disappear after powering on the rotor.</p>	<p>Check for:</p> <ul style="list-style-type: none"> Red Power LED on Microcontroller Module is illuminated 	<p>If measurement is bad:</p> <ul style="list-style-type: none"> See troubleshooting step above
	<ul style="list-style-type: none"> ADC module is plugged in correctly – Pin 1 on the module matches Pin on the Main Board 	<ul style="list-style-type: none"> Realign the ADC Module
	<ul style="list-style-type: none"> Check for +5VDC on Pin 2 of the ADC Module’s H3 (see image below for ADC pins) 	<ul style="list-style-type: none"> Bad solder joint on either the ADC Module’s’ male H3 header, or the Main Board’s female H3 header. Bad +5VDC Linear Regulator (U2)
		
	<ul style="list-style-type: none"> Remove power and confirm continuity between Pin 4 of the ADC Module’s H3 and Pin 4 of the MCU Module’s H2 (SCL) (see image below for MCU pins) 	<ul style="list-style-type: none"> Bad solder joint on either the ADC Module’s’ male H3 header, or the Main Board’s female H3 header. Bad solder joint on either the MCU’s male H2 header, or the Main Board’s female H2 header.
<ul style="list-style-type: none"> Remove power and confirm continuity between Pin 5 of the ADC Module’s H3 and Pin 2 of the MCU Module’s H1 (SDA) (see image below for MCU pins) 	<ul style="list-style-type: none"> Bad solder joint on either the ADC Module’s’ male H3 header, or the Main Board’s female H3 header. Bad solder joint on either the MCU’s male H1 header, or the Main Board’s female H1 header. 	

Symptom	Possible Solutions
	<div data-bbox="581 310 1344 751" style="text-align: center;"> <p>Pin 2 H1 - SDA</p> <p>Pin 4 H2 - SCL</p> </div> <ul style="list-style-type: none"> <li data-bbox="500 772 711 806" style="display: inline-block; width: 50%;">• All checks pass <li data-bbox="1019 772 1386 835" style="display: inline-block; width: 50%;">• Faulty ADC Module – Contact WA4MCMkits

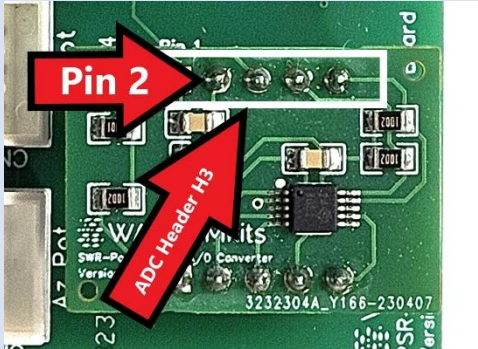
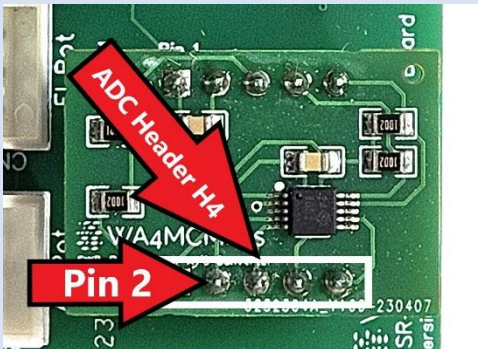
Symptom	Possible Solutions	
<p>The azimuth angle being displayed in the companion application doesn't change with the rotation of the azimuth potentiometer.</p>	<p>Check for:</p> <ul style="list-style-type: none"> • ADC module is plugged in correctly – Pin 1 on the module matches Pin on the Main Board 	<p>If measurement is bad:</p> <ul style="list-style-type: none"> • Realign the ADC Module
	<ul style="list-style-type: none"> • Check for +5VDC on Pin 2 of the ADC Module's H3 (see image below for ADC pins) 	<ul style="list-style-type: none"> • Bad solder joint on either the ADC Module's male H3 header, or the Main Board's female H3 header. • Bad +5VDC Linear Regulator (U2)
	<ul style="list-style-type: none"> • Remove power and measure 60kΩ between Pin 2 of the ADC Module's H4 and the center solder lug of the azimuth potentiometer 	<ul style="list-style-type: none"> • Bad solder joint on either the ADC Module's male H4 header, any of the CN4 (Az Pot) pins, or the Azimuth potentiometer's solder lugs. • Bad solder joints on either R10 (220kΩ, or R11 (1MΩ)
	<ul style="list-style-type: none"> • All checks pass 	<ul style="list-style-type: none"> • Faulty ADC Module – Contact WA4MCMkits
<p>The elevation angle being displayed in the companion application doesn't change with the rotation of the elevation potentiometer.</p>	<p>Check for:</p> <ul style="list-style-type: none"> • ADC module is plugged in correctly – Pin 1 on the module matches Pin on the Main Board 	<p>If measurement is bad:</p> <ul style="list-style-type: none"> • Realign the ADC Module

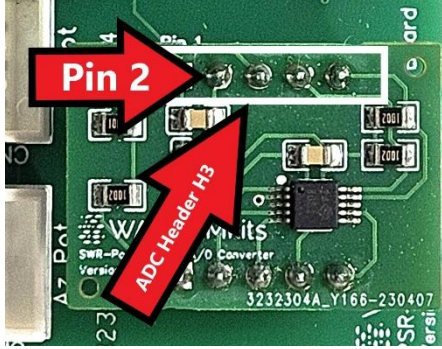
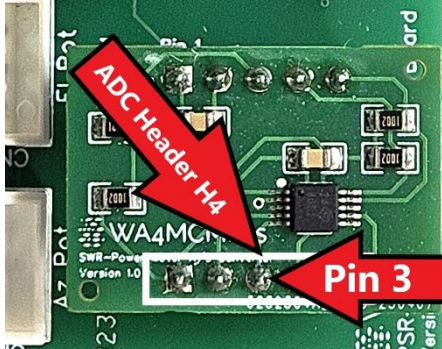
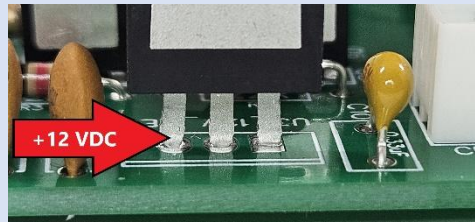
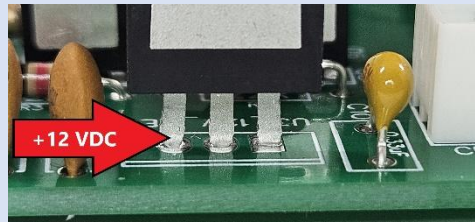
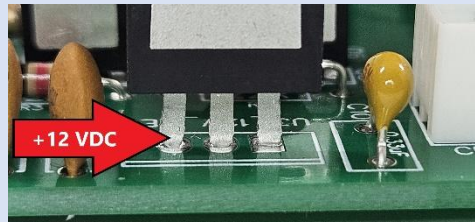
Symptom	Possible Solutions							
	<ul style="list-style-type: none"> Check for +5VDC on Pin 2 of the ADC Module's H3 (see image below for ADC pins) 	<ul style="list-style-type: none"> Bad solder joint on either the ADC Module's' male H3 header, or the Main Board's female H3 header. Bad +5VDC Linear Regulator (U2) 						
	<ul style="list-style-type: none"> Remove power and measure 60kΩ between Pin 3 of the ADC Module's H4 and the center solder lug of the elevation potentiometer 	<ul style="list-style-type: none"> Bad solder joint on either the ADC Module's' male H4 header, any of the CN5 (El Pot) pins, or the Azimuth potentiometer's solder lugs. Bad solder joints on either R9 (220kΩ, or R12 (1MΩ) 						
	<ul style="list-style-type: none"> All checks pass 	<ul style="list-style-type: none"> Faulty ADC Module – Contact WA4MCMkits 						
<p>The azimuth motor does not turn at all.</p>	<table border="1"> <thead> <tr> <th data-bbox="472 1356 1003 1423">Check for:</th> <th data-bbox="1003 1356 1453 1423">If measurement is bad:</th> </tr> </thead> <tbody> <tr> <td data-bbox="472 1423 1003 1776"> <ul style="list-style-type: none"> +12VDC on the output pin of the linear voltage regulator U3_12V_REG (see image below)  </td> <td data-bbox="1003 1423 1453 1776"> <ul style="list-style-type: none"> Bad solder on voltage regulator pin(s) Damaged circuit board trace(s) Voltage regulator installed backwards Faulty voltage regulator </td> </tr> <tr> <td data-bbox="472 1776 1003 1890"> <ul style="list-style-type: none"> The above reading is good </td> <td data-bbox="1003 1776 1453 1890"> <ul style="list-style-type: none"> Perform the checks for the azimuth motor CW and CCW movements </td> </tr> </tbody> </table>		Check for:	If measurement is bad:	<ul style="list-style-type: none"> +12VDC on the output pin of the linear voltage regulator U3_12V_REG (see image below) 	<ul style="list-style-type: none"> Bad solder on voltage regulator pin(s) Damaged circuit board trace(s) Voltage regulator installed backwards Faulty voltage regulator 	<ul style="list-style-type: none"> The above reading is good 	<ul style="list-style-type: none"> Perform the checks for the azimuth motor CW and CCW movements
Check for:	If measurement is bad:							
<ul style="list-style-type: none"> +12VDC on the output pin of the linear voltage regulator U3_12V_REG (see image below) 	<ul style="list-style-type: none"> Bad solder on voltage regulator pin(s) Damaged circuit board trace(s) Voltage regulator installed backwards Faulty voltage regulator 							
<ul style="list-style-type: none"> The above reading is good 	<ul style="list-style-type: none"> Perform the checks for the azimuth motor CW and CCW movements 							

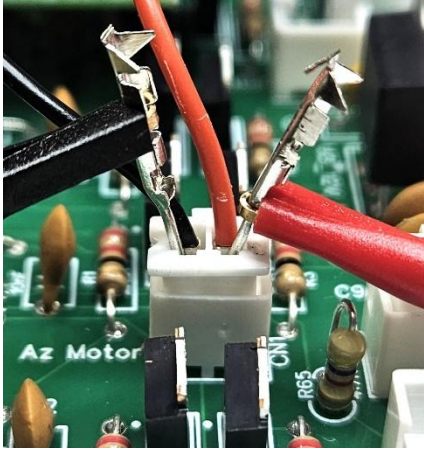
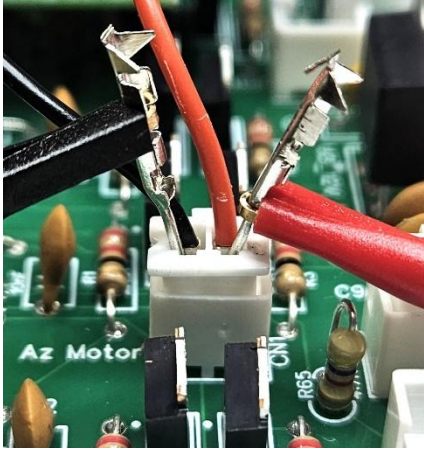
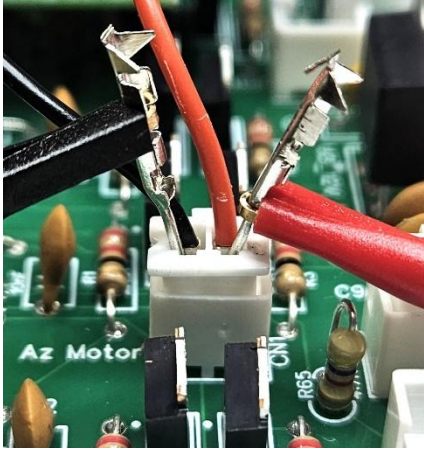
Symptom	Possible Solutions										
<p>The azimuth motor does not turn clockwise (CW).</p>	<table border="1" style="width: 100%; border-collapse: collapse;"> <tr> <td style="width: 50%; border: none;"> <p>Check for:</p> </td> <td style="width: 50%; border: none;"> <p>If measurement is bad:</p> </td> </tr> <tr> <td colspan="2" style="border: none;"> <p>The following measurement is performed with the black multimeter lead connected to the black wire of CN1 and the red multimeter lead connected to the red wire of CN1. Refer to the following image for one possible method for accomplishing this:</p> </td> </tr> <tr> <td colspan="2" style="border: none; text-align: center;">  </td> </tr> <tr> <td style="border: none;"> <ul style="list-style-type: none"> • About +11.7VDC while activating the manual azimuth switch in the CW direction (toggle towards the red wire) </td> <td style="border: none;"> <ul style="list-style-type: none"> • Bad solder on CN1 pins (Az Motor) • Q1 and/or Q2 and/or Q3 and/or Q4 installed backwards • Bad solder joints on any of the following components: Q1-Q4, R1-R4, D1, D2, C1, C2, C5, C6 • Either of the following components are faulty; Q1-Q4, D1, D2 • U1 is faulty – contact WA4MCMkits </td> </tr> <tr> <td style="border: none;"> <ul style="list-style-type: none"> • The above reading is good </td> <td style="border: none;"> <ul style="list-style-type: none"> • Bad solder connection for the motor wiring to either motor solder lug. • Bad Motor </td> </tr> </table>	<p>Check for:</p>	<p>If measurement is bad:</p>	<p>The following measurement is performed with the black multimeter lead connected to the black wire of CN1 and the red multimeter lead connected to the red wire of CN1. Refer to the following image for one possible method for accomplishing this:</p>				<ul style="list-style-type: none"> • About +11.7VDC while activating the manual azimuth switch in the CW direction (toggle towards the red wire) 	<ul style="list-style-type: none"> • Bad solder on CN1 pins (Az Motor) • Q1 and/or Q2 and/or Q3 and/or Q4 installed backwards • Bad solder joints on any of the following components: Q1-Q4, R1-R4, D1, D2, C1, C2, C5, C6 • Either of the following components are faulty; Q1-Q4, D1, D2 • U1 is faulty – contact WA4MCMkits 	<ul style="list-style-type: none"> • The above reading is good 	<ul style="list-style-type: none"> • Bad solder connection for the motor wiring to either motor solder lug. • Bad Motor
<p>Check for:</p>	<p>If measurement is bad:</p>										
<p>The following measurement is performed with the black multimeter lead connected to the black wire of CN1 and the red multimeter lead connected to the red wire of CN1. Refer to the following image for one possible method for accomplishing this:</p>											
											
<ul style="list-style-type: none"> • About +11.7VDC while activating the manual azimuth switch in the CW direction (toggle towards the red wire) 	<ul style="list-style-type: none"> • Bad solder on CN1 pins (Az Motor) • Q1 and/or Q2 and/or Q3 and/or Q4 installed backwards • Bad solder joints on any of the following components: Q1-Q4, R1-R4, D1, D2, C1, C2, C5, C6 • Either of the following components are faulty; Q1-Q4, D1, D2 • U1 is faulty – contact WA4MCMkits 										
<ul style="list-style-type: none"> • The above reading is good 	<ul style="list-style-type: none"> • Bad solder connection for the motor wiring to either motor solder lug. • Bad Motor 										

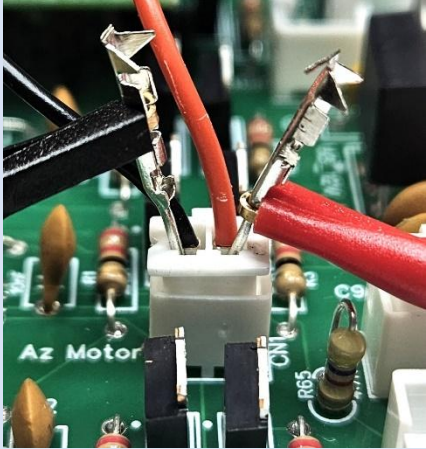
Symptom	Possible Solutions	
<p>The azimuth motor does not turn counterclockwise (CCW).</p>	<p>Check for:</p> <hr/> <p>The following measurement is performed with the black multimeter lead connected to the black wire of CN1 (Az Motor) and the red multimeter lead connected to the red wire of CN1 (Az Motor). Refer to the following image for one possible method for accomplishing this:</p> 	<p>If measurement is bad:</p> <hr/>
	<ul style="list-style-type: none"> About -11.7VDC while activating the manual azimuth switch in the CCW direction (toggle towards the yellow wire) 	<ul style="list-style-type: none"> Bad solder on CN1 pins (Az Motor) Q1 and/or Q2 and/or Q3 and/or Q4 installed backwards Bad solder joints on any of the following components: Q1-Q4, R1-R4, D1, D2, C1, C2, C5, C6 Either of the following components are faulty; Q1-Q4, D1, D2 U2 is faulty – contact WA4MCMkits
	<ul style="list-style-type: none"> The above reading is good 	<ul style="list-style-type: none"> Bad solder connection for the motor wiring to either motor solder lug. Bad Motor

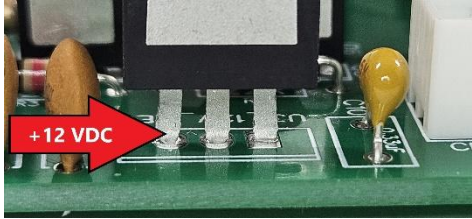
Symptom	Possible Solutions	
<p>The elevation motor does not turn at all.</p>	<p>Check for:</p> <ul style="list-style-type: none"> +12VDC on the output pin of the linear voltage regulator U3_12V_REG (see image below) 	<p>If measurement is bad:</p> <ul style="list-style-type: none"> Bad solder on voltage regulator pin(s) Damaged circuit board trace(s) Voltage regulator installed backwards Faulty voltage regulator
	<ul style="list-style-type: none"> The above reading is good 	<ul style="list-style-type: none"> Perform the checks for the elevation motor Down and Up movements

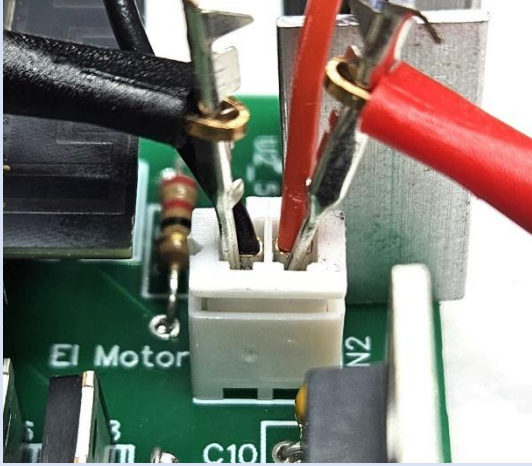
Symptom	Possible Solutions	
<p>The elevation motor does not turn clockwise (Down).</p>	<p>Check for: If measurement is bad:</p>	
	<p>The following measurement is performed with the black multimeter lead connected to the black wire of CN2 (EI Motor) and the red multimeter lead connected to the red wire of CN2 (EI Motor). Refer to the following image for one possible method for accomplishing this:</p>	
		
<ul style="list-style-type: none"> About +11.7VDC while activating the manual elevation switch in the CW (Down) direction (toggle towards the yellow wire) 	<ul style="list-style-type: none"> Bad solder on CN2 pins (Az Motor) Q5 and/or Q6 and/or Q7 and/or Q8 installed backwards Bad solder joints on any of the following components: Q5-Q8, R5-R8, D3, D4, C3, C4, C7, C8 Either of the following components are faulty; Q5-Q8, D3, D4 U3 is faulty – contact WA4MCMkits 	
<ul style="list-style-type: none"> The above reading is good 	<ul style="list-style-type: none"> Bad solder connection for the motor wiring to either motor solder lug. Bad Motor 	

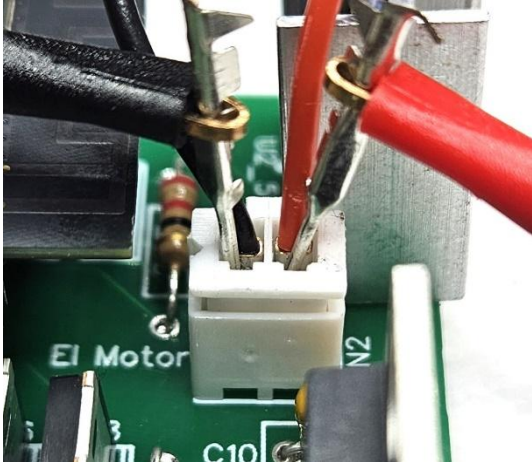
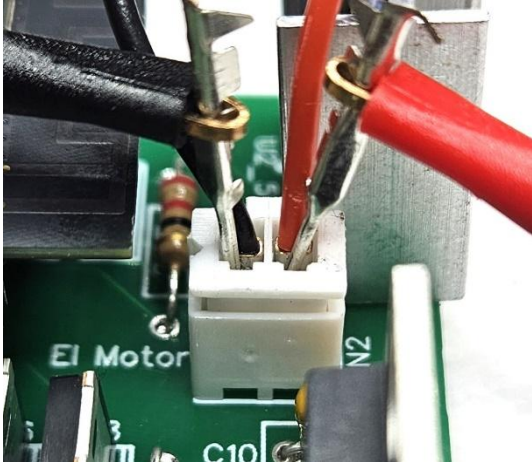
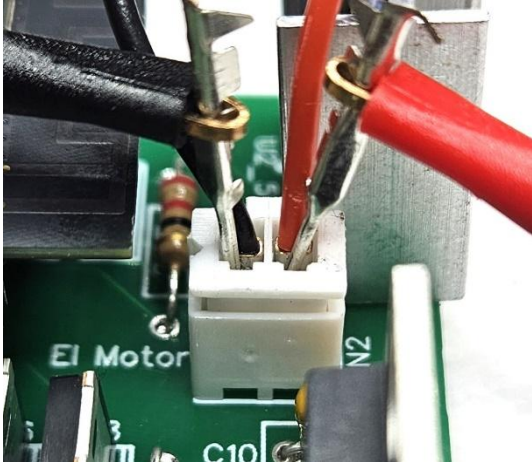
Symptom	Possible Solutions								
<p>The elevation motor does not turn counterclockwise (Up).</p>	<table border="1" style="width: 100%; border-collapse: collapse;"> <thead> <tr> <th style="width: 50%; text-align: left;">Check for:</th> <th style="width: 50%; text-align: left;">If measurement is bad:</th> </tr> </thead> <tbody> <tr> <td colspan="2" style="text-align: center;"> <p>The following measurement is performed with the black multimeter lead connected to the black wire of CN2 (EI Motor) and the red multimeter lead connected to the red wire of CN2 (EI Motor). Refer to the following image for one possible method for accomplishing this:</p>  </td> </tr> <tr> <td style="vertical-align: top;"> <ul style="list-style-type: none"> • About +11.7VDC while activating the manual elevation switch in the CCW (Up) direction (toggle towards the red wire) </td> <td style="vertical-align: top;"> <ul style="list-style-type: none"> • Bad solder on CN2 pins (Az Motor) • Q5 and/or Q6 and/or Q7 and/or Q8 installed backwards • Bad solder joints on any of the following components: Q5-Q8, R5-R8, D3, D4, C3, C4, C7, C8 • Either of the following components are faulty; Q5-Q8, D3, D4 • U4 is faulty – contact WA4MCMkits </td> </tr> <tr> <td style="vertical-align: top;"> <ul style="list-style-type: none"> • The above reading is good </td> <td style="vertical-align: top;"> <ul style="list-style-type: none"> • Bad solder connection for the motor wiring to either motor solder lug. • Bad Motor </td> </tr> </tbody> </table>	Check for:	If measurement is bad:	<p>The following measurement is performed with the black multimeter lead connected to the black wire of CN2 (EI Motor) and the red multimeter lead connected to the red wire of CN2 (EI Motor). Refer to the following image for one possible method for accomplishing this:</p> 		<ul style="list-style-type: none"> • About +11.7VDC while activating the manual elevation switch in the CCW (Up) direction (toggle towards the red wire) 	<ul style="list-style-type: none"> • Bad solder on CN2 pins (Az Motor) • Q5 and/or Q6 and/or Q7 and/or Q8 installed backwards • Bad solder joints on any of the following components: Q5-Q8, R5-R8, D3, D4, C3, C4, C7, C8 • Either of the following components are faulty; Q5-Q8, D3, D4 • U4 is faulty – contact WA4MCMkits 	<ul style="list-style-type: none"> • The above reading is good 	<ul style="list-style-type: none"> • Bad solder connection for the motor wiring to either motor solder lug. • Bad Motor
Check for:	If measurement is bad:								
<p>The following measurement is performed with the black multimeter lead connected to the black wire of CN2 (EI Motor) and the red multimeter lead connected to the red wire of CN2 (EI Motor). Refer to the following image for one possible method for accomplishing this:</p> 									
<ul style="list-style-type: none"> • About +11.7VDC while activating the manual elevation switch in the CCW (Up) direction (toggle towards the red wire) 	<ul style="list-style-type: none"> • Bad solder on CN2 pins (Az Motor) • Q5 and/or Q6 and/or Q7 and/or Q8 installed backwards • Bad solder joints on any of the following components: Q5-Q8, R5-R8, D3, D4, C3, C4, C7, C8 • Either of the following components are faulty; Q5-Q8, D3, D4 • U4 is faulty – contact WA4MCMkits 								
<ul style="list-style-type: none"> • The above reading is good 	<ul style="list-style-type: none"> • Bad solder connection for the motor wiring to either motor solder lug. • Bad Motor 								

Symptom	Possible Solutions	
<p>The Flip Switch has no effect.</p>	<p>Check for:</p>	<p>If measurement is bad:</p>
	<ul style="list-style-type: none"> • +3.3VDC on the red wire connected to the flip switch • +3.3VDC on pin 1 of the MCU header H1 when the flip switch is in the On position 	<ul style="list-style-type: none"> • Bad solder on the CN6 pin connected to the red wire. • Bad solder on the CN6 pin connected to the black wire.

CIRCUIT BOARD IMAGES

MAIN BOARD, MCU MODULE, AND ANALOG TO DIGITAL CONVERTER MODULE:

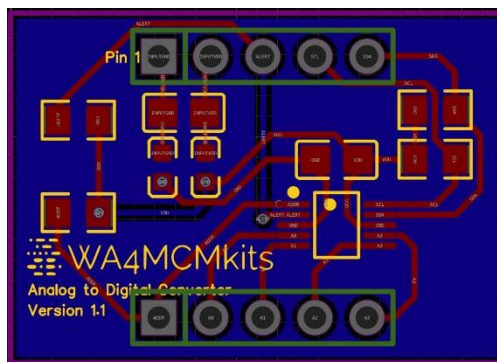
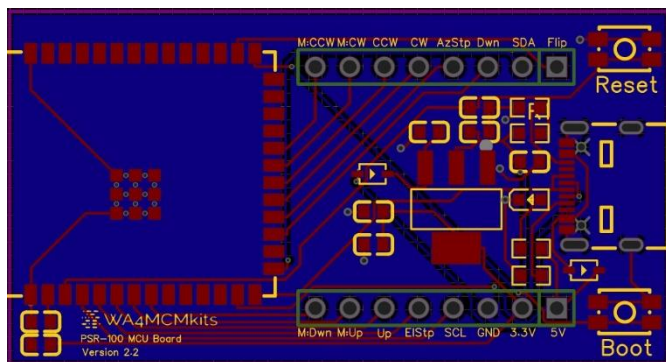
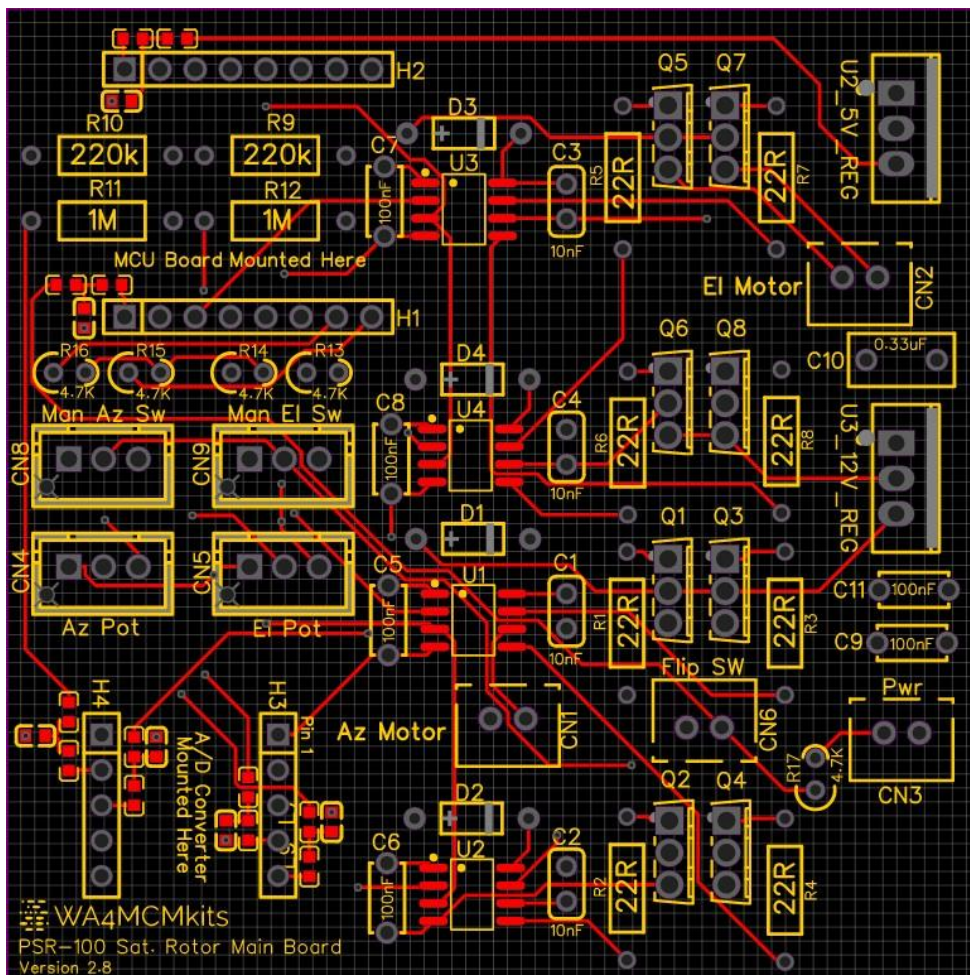

Yellow: Components mounted on the board's top side; green: components mounted on the board's underside.

WiFi ACCESS POINT MODULE BOARD:

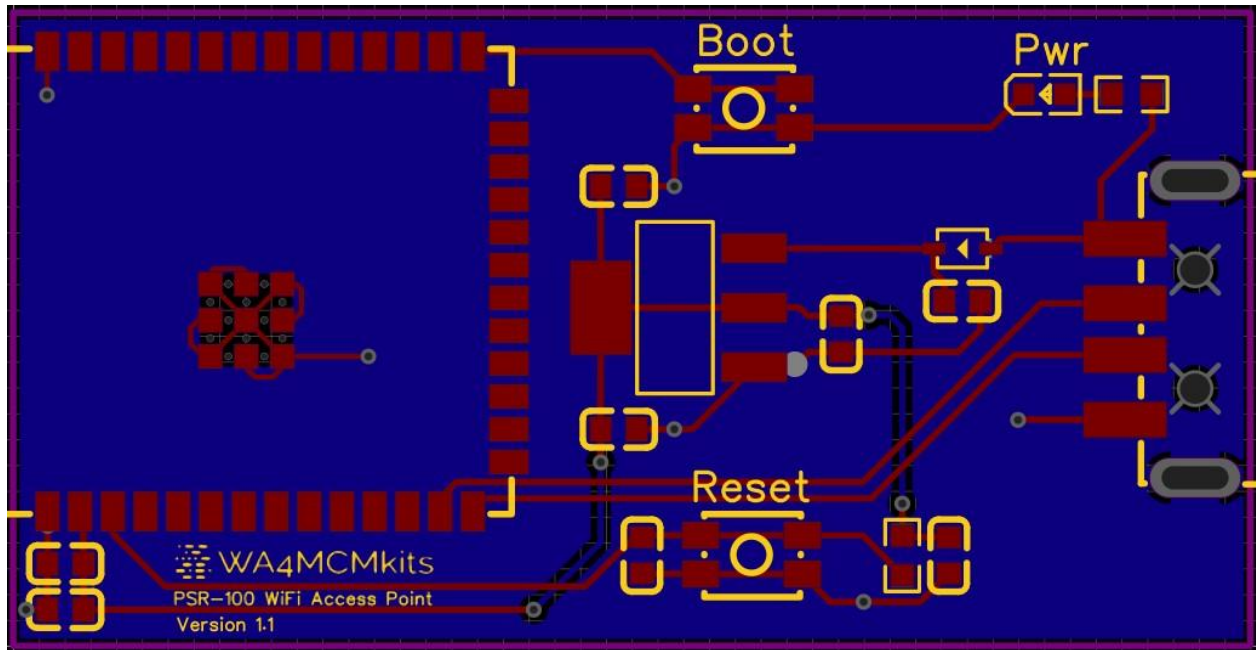

SCHEMATIC DIAGRAMS

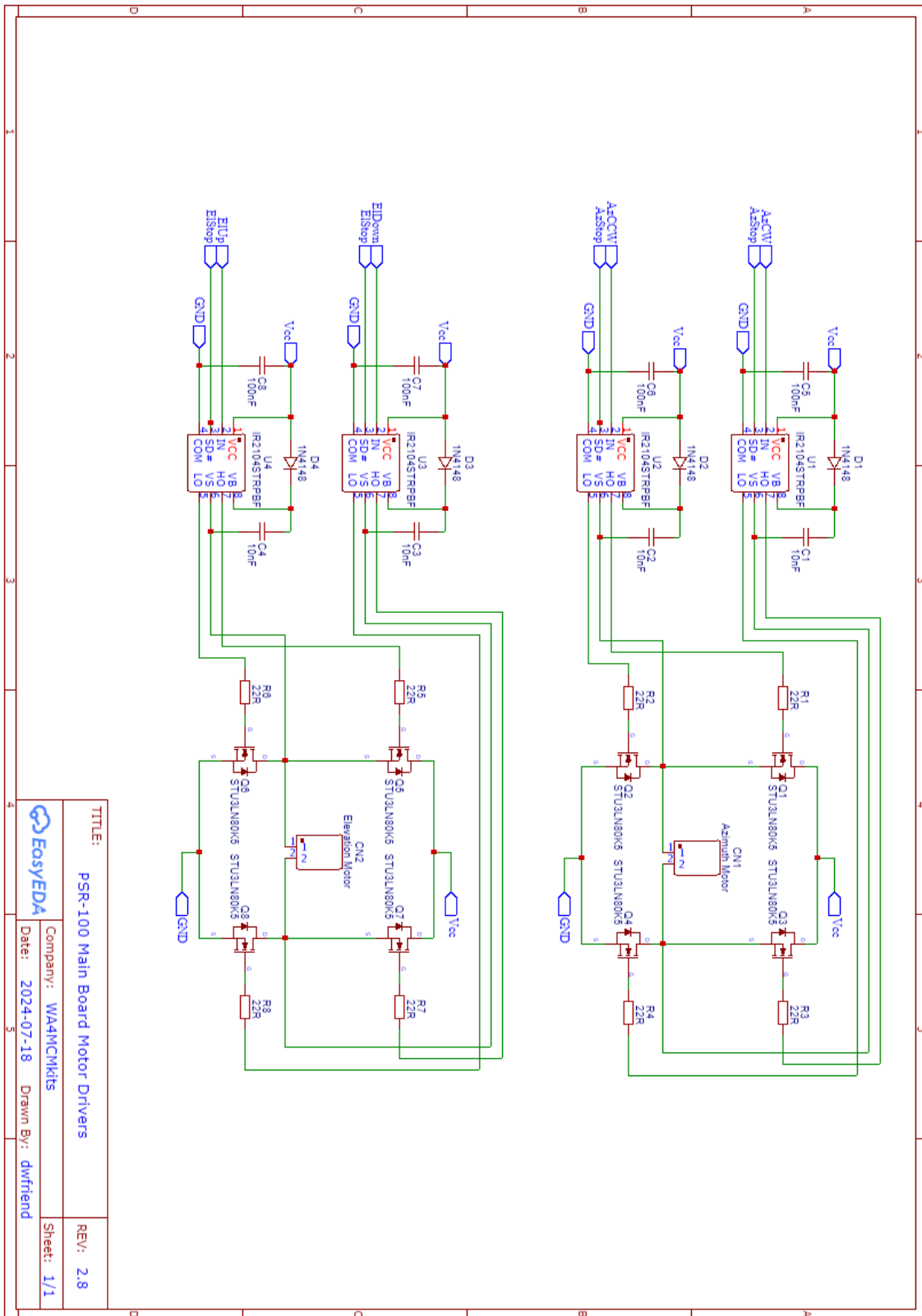

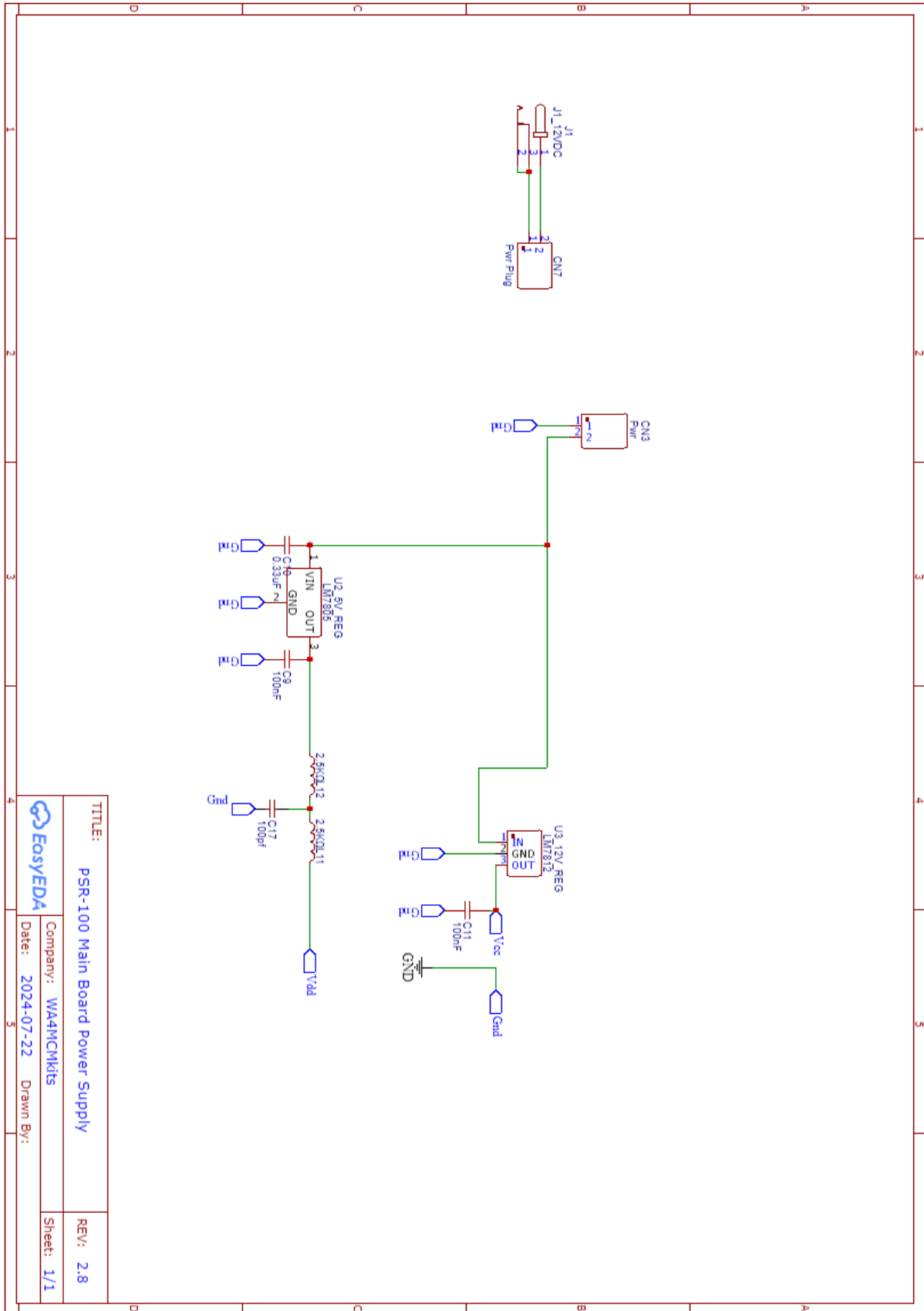

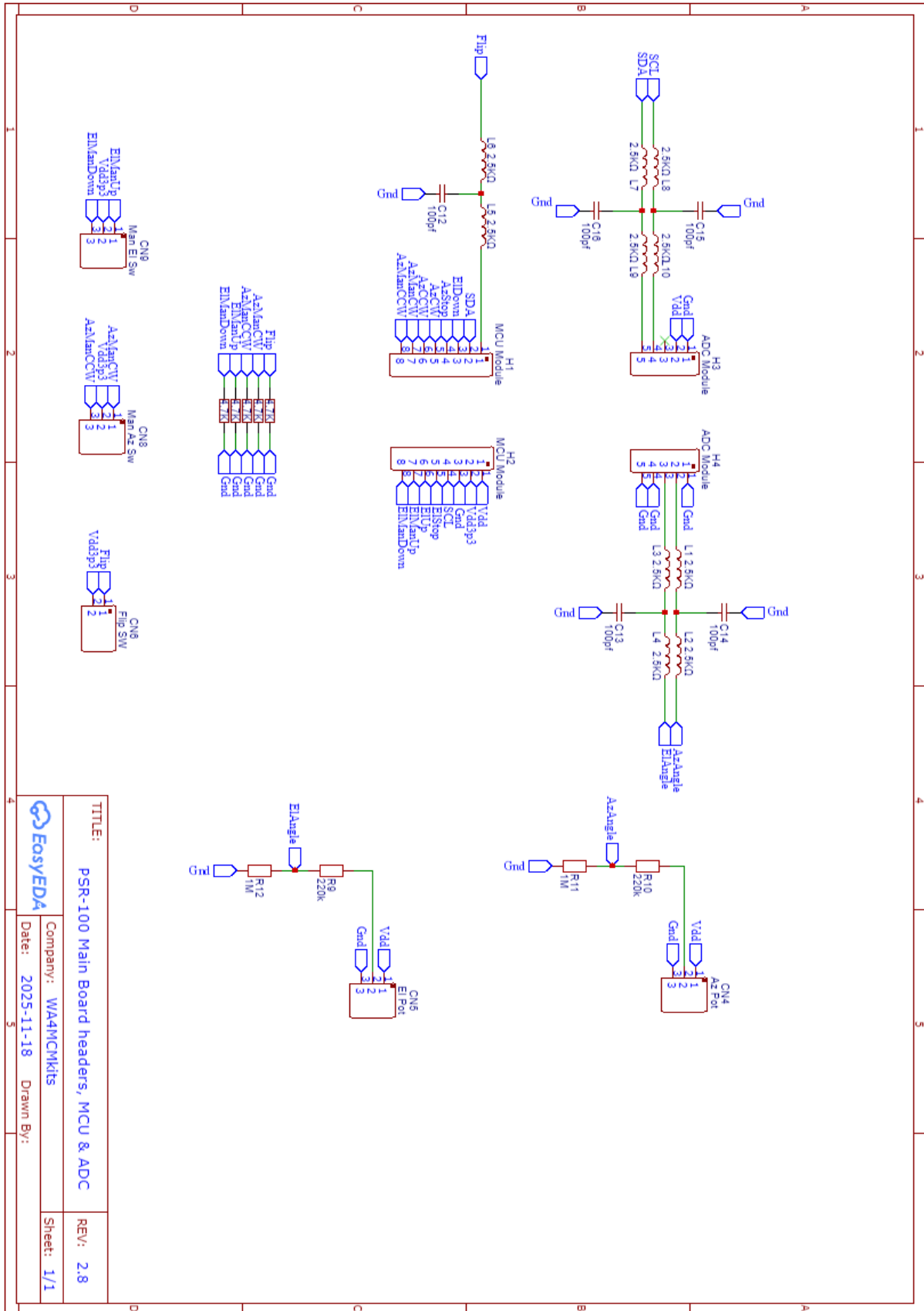

TITLE: PSR-100 Main Board headers, MCU & ADC	
Company: WA4MCMkits	REV: 2.8
Date: 2025-11-18	Sheet: 1/1
Drawn By:	

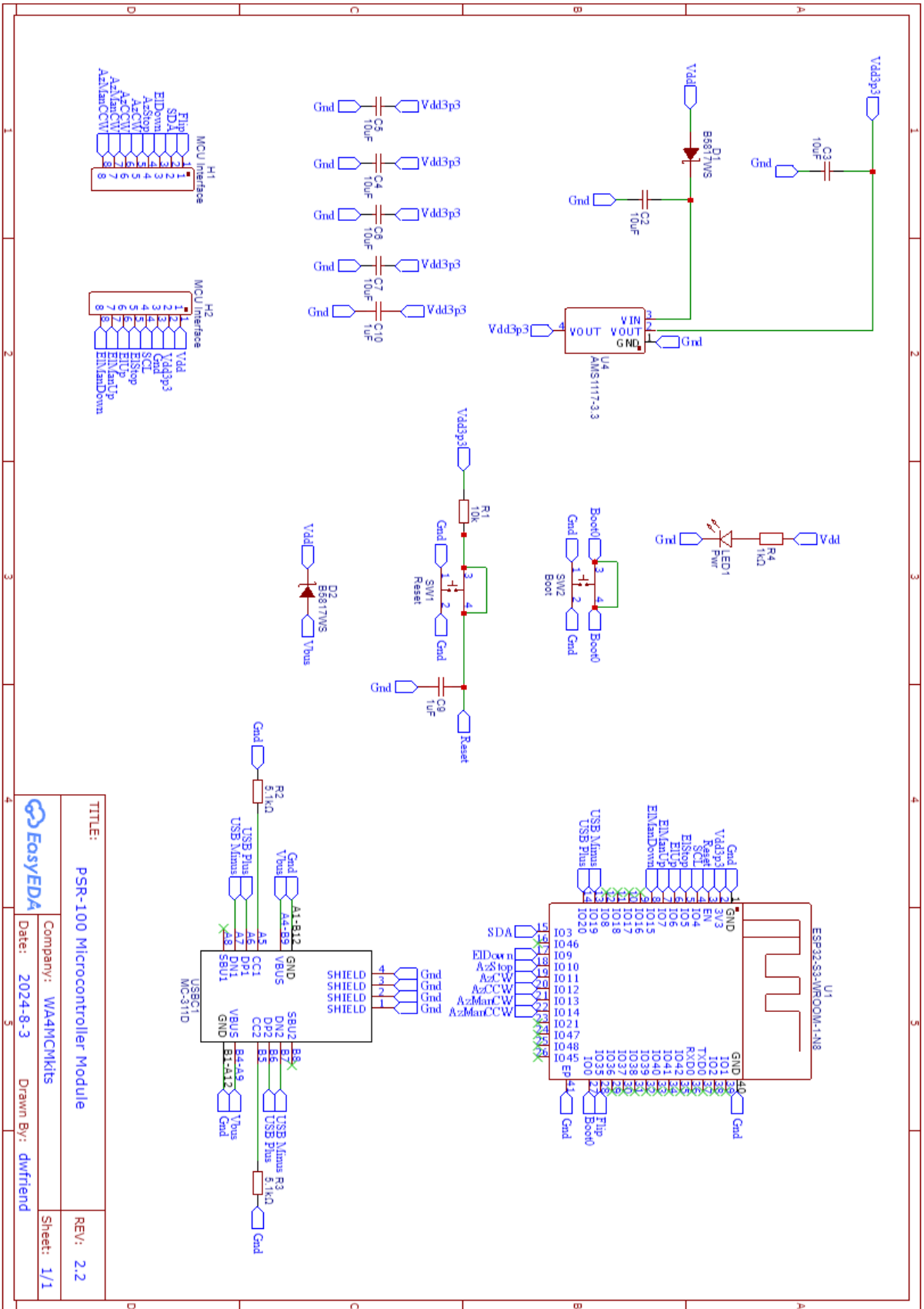

TITLE:	PSR-100 Microcontroller Module
Company:	WA4MCMkits
Date:	2024-8-3
Drawn By:	dwfriend
REV:	2.2
Sheet:	1/1

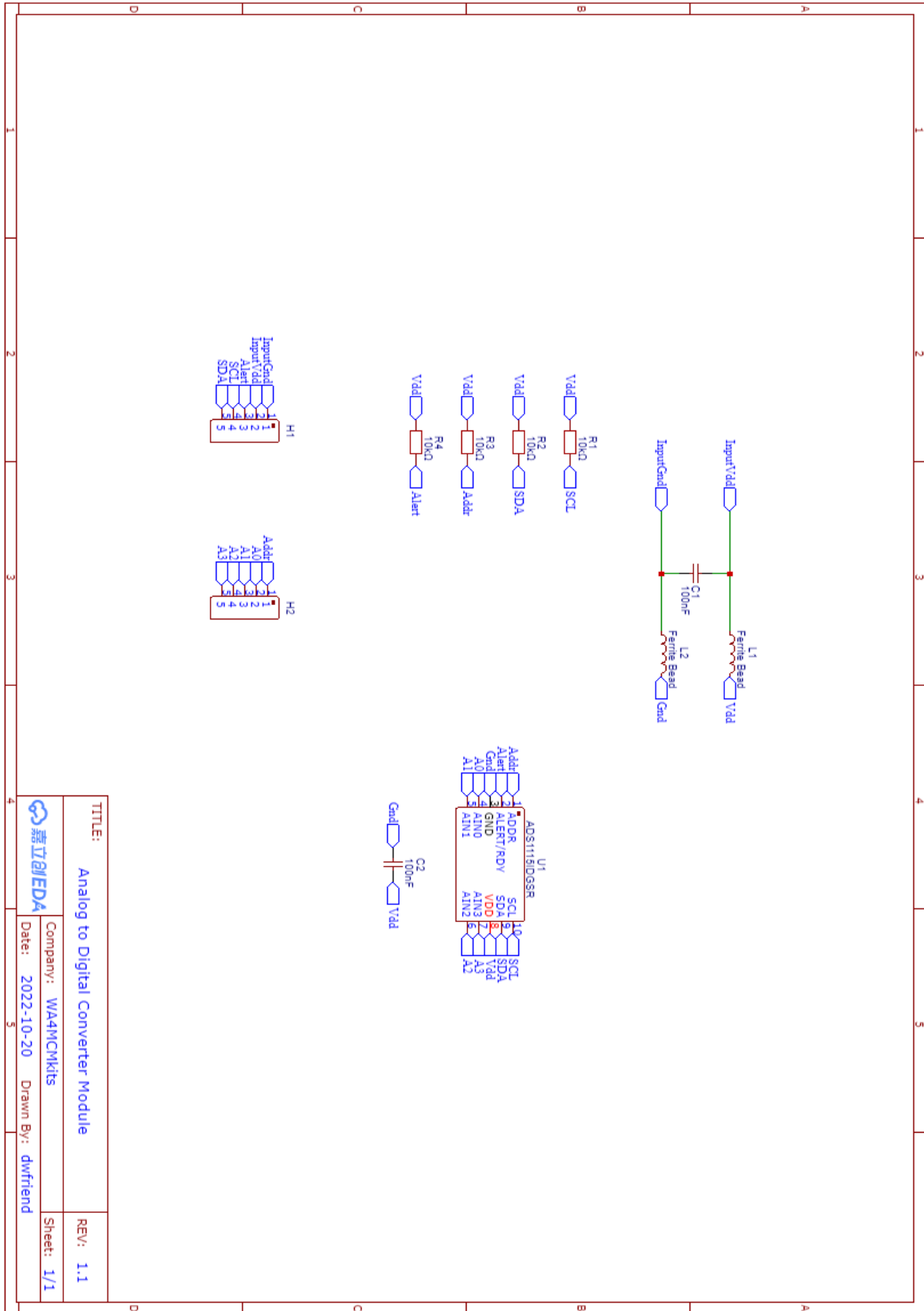

TITLE: Analog to Digital Converter Module		REV: 1.1
Company: WA4MCMkits		Sheet: 1/1
Date: 2022-10-20	Drawn By: dwfriend	